

PH.D. THESIS

---

**EXAMINATION OF PITUITARY ADENYLATE-CYCLASE ACTIVATING POLYPEPTIDE  
IN CARDIOVASCULAR DISEASES**

---

Dóra Szabó M.D.



Supervisors: *Zsolt Sárszegi, M.D., Ph.D.*

University of Pécs, Clinical Center, Heart Clinic

*Andrea Tamás, M.D., Ph.D.*

University of Pécs, Medical School, Department of Anatomy

Program leader: István Szokodi M.D., Ph.D., D.Sc.

Head of Doctoral School: Lajos Bogár M.D., Ph.D., D.Sc.

2022

# I. INTRODUCTION

---

## 1.1. *Pituitary adenylate-cyclase activating polypeptide (PACAP)*

Pituitary adenylate-cyclase activating polypeptide (PACAP) is a multifunctional neuropeptide acting on three different receptors: the PAC1, VPAC1 and VPAC2 receptors. Anti-apoptotic, anti-oxidant, anti-ischemic and anti-inflammatory effects of PACAP are well-known. There are two biologically active forms of PACAP containing 27 (PACAP-27) or 38 amino acids (PACAP-38). More than 90% of the endogenous PACAP exists as PACAP-38. PAC1 receptor expression has already been confirmed in cultured cardiomyocytes, in mouse myocardium and also in human cardiac tissue. Numerous in vitro studies have proven the cardioprotective effects of PACAP against ischemia and oxidative stress induced lesions due to the activation of different antiapoptotic factors and inhibition of the pro-apoptotic pathways. In a myocardial infarction mouse model significant elevated PACAP-38 immunoreactivity was detected in the left ventricle, and also in extracellular matrix, myocytes and macrophages emphasizing the importance of PACAP in cardiac remodeling.

Based on earlier studies, PACAP seems to ameliorate the prognosis primarily in cardiovascular diseases (such as heart failure [HF] and ischemic heart disease), which are propelled by oxidative stress and/or apoptosis. Sano and co-workers were the first to demonstrate the cardioprotective effect of PACAP revealing that PACAP can diminish myocardial fibrosis. Besides cardiac remodeling, neurohormonal activation and necrosis, apoptosis is also involved in the pathomechanism of HF. The cardioprotective effect of PACAP was proved in several in vitro and animal cardiotoxicity models due to different antiapoptotic mechanisms. In doxorubicin-induced cardiomyopathy significantly higher mortality and more severe HF was observed in PACAP-deficient mice compared to wild types.

Therefore, in our study we examined clinically relevant cardiovascular diseases with high mortality and morbidity having a potential correlation with PACAP based on their etiology and pathomechanism.

## 1.2. *The examined cardiovascular diseases*

Despite modern interventional therapeutic options, acute myocardial infarction (MI) is still one of the most common causes of cardiovascular mortality and morbidity. Cardiac biomarkers, especially high-sensitive cardiac troponin (hs-cTn), play an important role in the diagnosis of MI. However, the latest recommendations highlight the complexity of the clinical circumstances, making the differentiation difficult between ischemic and non-ischemic conditions associated with increased cTn levels. Therefore, the latest studies have focused on the detection of potential new biomarkers, possessing additional diagnostic or prognostic values, next to the routine parameters.

To study the different underlying molecular processes of MI, several animal models are used for research. Among them the catheter based closed-chest myocardial infarction large animal models are the most reliable models using clinically relevant interventional techniques and protocols, also including different pre- and post- and remote conditioning maneuvers.

Beside MI, HF is the most common cause of cardiac death. Ischemic (ICM) and non-ischemic cardiomyopathy (NICM) are the most prevalent underlying diseases of HF. Several factors, such as oxidative stress, cardiomyocyte necrosis, apoptosis and a range of adaptive mechanisms including neurohumoral imbalance, increased sympathetic activation, increased

## *I. INTRODUCTION – II. OBJECTIVES*

---

cytokine release, different pro- and anti-inflammatory factors play important roles in the pathophysiology and progression of the disease. Earlier studies showed that levels of various pro-inflammatory cytokines (e.g.: IL-1 $\beta$ , IL-2, IL-6, TNF- $\alpha$ ), chemokines (e.g.: monocyte chemotactic protein – MCP-1) and neutrophil-specific chemokines (different CXC chemokines) are altered and often strongly correlated with the severity of HF with reduced ejection fraction (HFrEF). These factors promote the development of myocardial remodeling with cardiomyocyte apoptosis and enhanced interstitial fibrosis, eventually aggravating the decrease of left ventricular systolic function.

The most common clinically relevant parameters for the evaluation of the severity of HFrEF are the i) left ventricular ejection fraction (EF), ii) plasma N-terminal pro-brain natriuretic peptide (NT-proBNP) level and iii) functionally New York Heart Association (NYHA) classification. However, EF or NT-proBNP may change within treatment and not always correctly predict prognosis. Therefore, new factors are investigated to be potential predictive biomarkers for HF prognosis.

## *II. OBJECTIVES*

---

Based on the results of earlier studies we examined two clinically relevant cardiac diseases which may show an interesting correlation with PACAP-38.

### *2.1. Examination of acute myocardial infarction (AMI)*

The aim of our present translational study was to examine the differences between the plasma and tissue PACAP-38 levels of the AMI and healthy control groups. Our first goal was to examine tissue PACAP-38 levels in different myocardial (left ventricular, left and right atrial) tissue samples in a clinically relevant, close-chest porcine model of reperfused MI. Moreover, we also determined the effects of special pre- and postconditioning paradigms on tissue PACAP-38 alterations.

### *2.2. Examination of heart failure (HF) patients*

The aim of our HF study was to measure the alterations of plasma PACAP-38 levels in acute and chronic HF caused by ischemic or non-ischemic cardiomyopathy compared to age-matched healthy controls. We also planned to examine the potential correlations between PACAP-38 and other HF predictors, such as NT-proBNP, echocardiographic, routine laboratory parameters and different cytokines (IL-1 $\beta$ , IL-2, IL-4, IL-6, IL-10, IFN- $\gamma$ , TNF- $\alpha$ ). Moreover, tissue PACAP-38 levels were also investigated with PACAP-38 ELISA and PAC1 receptor level was examined with Western blot techniques in heart tissue samples of patients with end-stage cardiomyopathy compared to healthy controls.

### III. METHODS

#### 3.1. Examination of acute myocardial infarction (AMI)

##### 3.1.1. Tissue PACAP-38 measurements in porcine model of AMI

A closed-chest porcine model of reperfused acute myocardial infarction has been studied including 38 female pigs in a collaboration with the coworkers of the Department of Pharmacology and Pharmacotherapy at Semmelweis University. After 90 minutes of LAD occlusion reperfusion was performed. The animals were sacrificed 3 or 72 hours later and myocardial tissue samples were collected from ischemic (I) and non-ischemic (NI) regions of the left ventricle (LV). The LV samples from the Sham hearts were collected from regions equivalent to the LV-NI and LV-I regions of MI hearts. Moreover, we also completed different pre- and postconditioning techniques on this model. The different groups are presented on *Figure 1*.

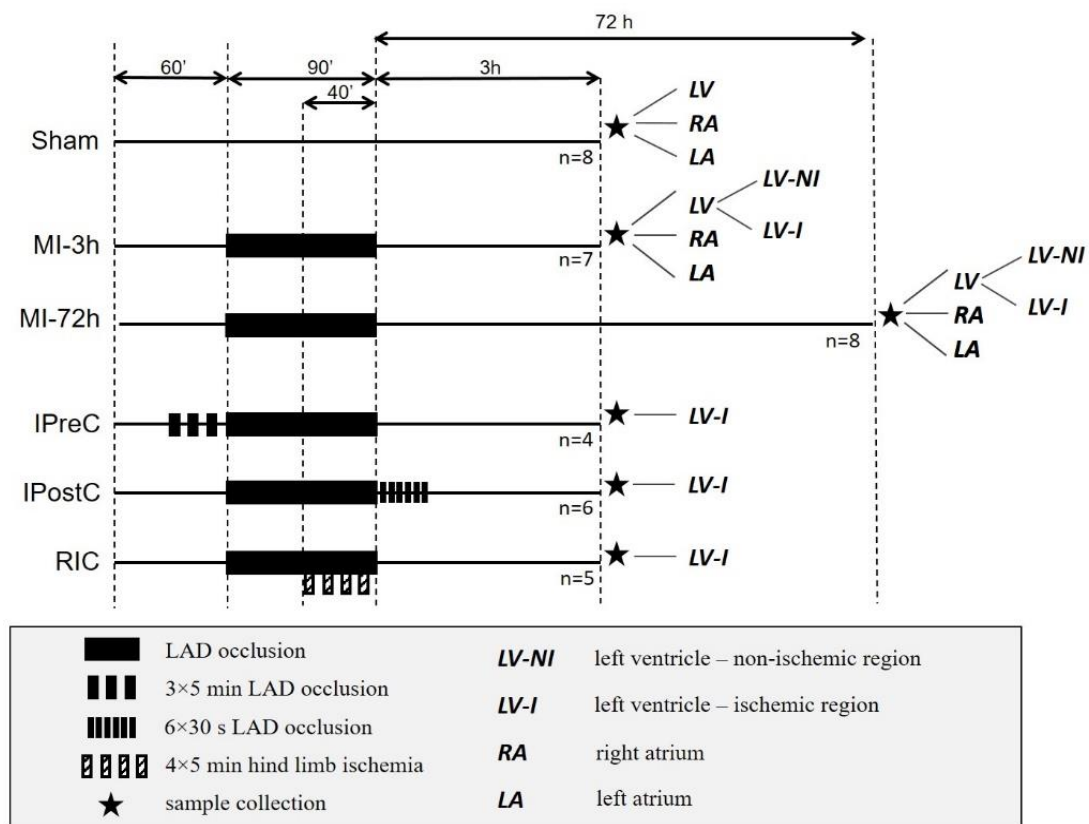

*Figure 1. Groups of our clinically relevant, closed-chest porcine model of reperfused acute myocardial infarction. Sham: Sham-operated group; MI-3 h: myocardial infarction group with 3-h reperfusion; MI-72 h: myocardial infarction group with 72-h reperfusion; IPreC: ischemic preconditioning group; IPostC: ischemic postconditioning group; RIC: remote ischemic conditioning group.*

The collected tissue samples were snap-frozen immediately after removal in liquid nitrogen and sonicated on ice. Then, the homogenates were centrifuged and the collected supernatants were further processed for PACAP-38 specific sandwich-type enzyme-linked immunosorbent assay (ELISA).

### III. METHODS

#### 3.1.2. The human AMI study

Twenty patients with the diagnosis of ST-segment elevation myocardial infarction (STEMI) and 12 controls were enrolled into the present study. Patients were admitted to our clinic with the diagnosis of acute ST-elevation myocardial infarction on average 4–6 h after the beginning of the symptoms. The detailed protocol of the examination is presented in Figure 2.

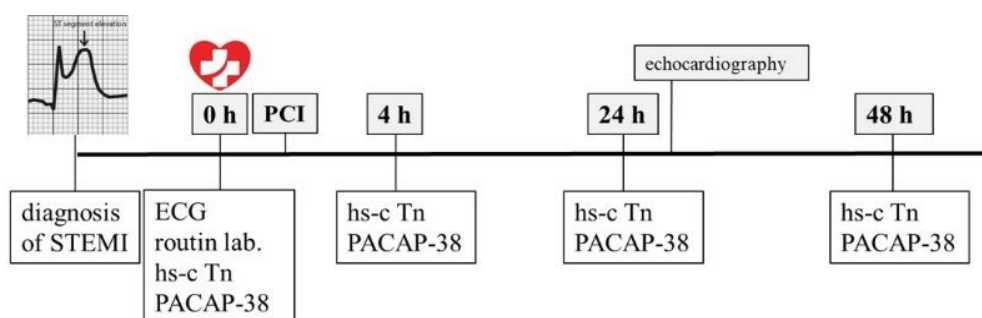

Figure 2. Human study protocol. STEMI: ST-elevation myocardial infarction, ECG: electrocardiography, lab.: laboratory examinations, hs-cTn: hypersensitive cardiac troponin.

#### 3.1.3. Measurement of PACAP-38-like immunoreactivity

For determination of PACAP-38-like immunoreactivity (LI) in cardiac tissue homogenates and plasma samples sandwich-type enzyme-linked immunosorbent assay (human PACAP-38 ELISA kit) was used according to the protocol provided by the manufacturer. All measured PACAP-38 levels are shown in pg/mL.

### 3.2. Examination of heart failure (HF) patients

#### 3.2.1. Examination of plasma PACAP-38 levels in patients with different stage of dilated cardiomyopathy (DCM)

Forty-one chronic HF patients with DCM were enrolled in our preliminary study. Based on the etiology of DCM two different subgroups were created: primary (n= 9) and ischemic (n= 33) DCM. Blood collection was performed for general laboratory tests, NT-proBNP and PACAP-38-LI measurements. For the determination of PACAP-38-LI radioimmunoassay (RIA) method was performed. PACAP38 specific antiserum (88111-3) was applied, which was raised against a conjugate of Cys(23)-PACAP(24-38) and bovine thyroglobulin coupled by carbodiimide in rabbits. Ovine PACAP38 peptide was used as a RIA standard ranging from 0 to 1000 fmol/ml. Mono<sup>125</sup>I-labeled ovine PACAP24-38 C-terminal fragment was applied as a RIA tracer prepared in the Department of Pharmacology and Pharmacotherapy, University of Pecs.

### III. METHODS

---

#### 3.2.2. Comparative examination of PACAP-38 levels in acute, decompensated HF, chronic, compensated HF and healthy controls

In the second part of our HF with reduced ejection fraction (HFrEF) study we examined 13 patients with acute, decompensated HF, 33 chronic, compensated HF and 13 gender and aged-matched control patient. Similar to the previous study blood test were performed for general laboratory tests, NT-proBNP, PACAP-38-LI and different cytokine measurements. PACAP-38-LI assessment was performed with ELISA method. Concentrations of 7 characteristic pro-, and anti-inflammatory cytokines (IL-1 $\beta$ , IL-2, IL-4, IL-6, IL-10, IFN-g, TNF-a) were also measured with the high sensitivity Invitrogen™ Human Cytokine 7-Plex ProcartaPlex™ Panel with Luminex array according to the manufacturer's instructions.

#### 3.2.3. Examination of cardiac tissue samples of HF patients

Human heart samples were collected in the Department of Heart Failure and Transplantology, Cardinal Stefan Wyszyński National Institute of Cardiology, Warszawa, Poland. Healthy human hearts were obtained from organ donor patients (control,  $n = 12$ ). Explanted failing hearts were obtained from patients suffering from advanced HF of non-ischemic (NICM,  $n=11$ ) or ischemic (ICM,  $n=12$ ) etiology. Human left ventricular tissue samples were taken from free wall, at the time of heart explantation (avoiding scarred, fibrotic, or adipose tissue, endocardium, epicardium, or coronary vessels). The samples were rinsed immediately in physiological saline, blotted dry, frozen in liquid nitrogen. After homogenization and centrifugation ELISA measurement was performed for the detection of PACAP-38-LI. In order to investigate whether PAC1 receptor level is altered at the protein level in the homogenates of heart samples, Western blot was performed as previously described in our laboratory with modifications (*Baranyai et al. 2015*).

#### 3.3. Statistical analysis

For statistical analysis SPSS 22 Program was used. Kolmogorov-Smirnov and Shapiro-Wilk normality test were performed showing normally distributed data. To detect the potential differences between the examined groups one-way ANOVA with Tukey or Bonferroni post hoc tests or Friedman test with Wilcoxon post hoc test or Mann-Whitney tests were used. The interaction between PACAP-38 and the different biomarkers, cytokine levels and other potential impacting factors (comorbidities, echocardiographic parameters, therapy and routine laboratory parameters) were tested with Spearman's correlation. Multivariate regression analysis was performed to examine the additive effects of the main influencing factors. In all cases  $p < 0.05$  was considered statistically significant.

## IV. RESULTS

### 4.1. Examination of AMI

#### 4.1.1. Changes of tissue PACAP-38 levels in porcine model of acute myocardial infarction

To detect tissue level of PACAP-38, we examined the Sham-operated pig hearts without myocardial infarction (MI) in the left ventricle (LV) and left and right atrium (LA, RA), detecting significantly higher PACAP-38 levels in LV compared to both atria (*Figure 3.A*). PACAP-38 level was measured in samples originated from different left ventricular (ischemic and non-ischemic LV) regions in Sham and MI groups (MI-LV-I and MI-LV-NI). We did not find significant differences between the two regions of the Sham-operated hearts, thus we used one Sham group containing all Sham LV samples. Although, there was no significant difference between the relative PACAP levels in the ischemic LV samples (MI-LV-I) and the Sham hearts, the PACAP-38 level was significantly lower in the non-ischemic left ventricular samples of MI hearts (MI-LV-NI) compared to ischemic and also to the Sham LV (*Figure 3.B*).

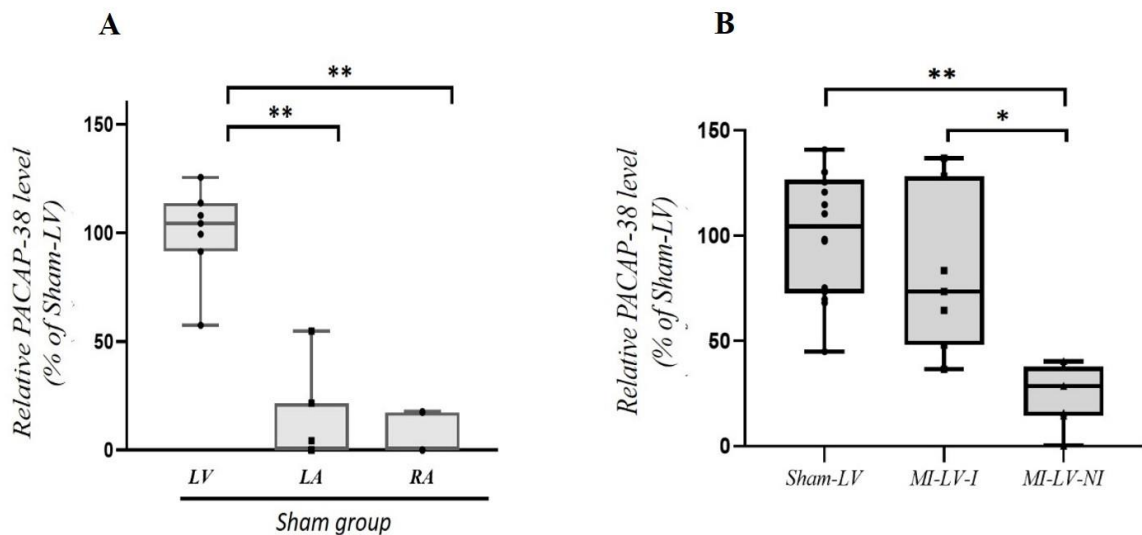

*Figure 3. Tissue PACAP-38 levels in different heart samples. (A) Comparison of tissue PACAP-38 levels in left ventricular (LV), left atrial (LA) and right atrial (RA) samples of healthy Sham-operated animals. (B) Comparison of tissue PACAP-38 levels in Sham left ventricular (Sham LV) samples and the ischemic left ventricular (MI-LV-I) and non-ischemic left ventricular (MI-LV-NI) samples of myocardial infarction (MI) animal hearts. \*  $p < 0.05$ , \*\*  $p < 0.001$  vs. Sham-operated LV.  $n = 7-8$ .*

In the MI porcine group PACAP-38 level was compared between different heart chambers and regions. Ischemic (LV-I) and non-ischemic (LV-NI) left ventricular samples and atria samples (RA, LA) were utilized after 3 h and after 72 h of reperfusion. Significantly lower tissue PACAP-38 levels were detected in the non-ischemic left ventricle (LV-NI) compared to the ischemic region (LV-I) in both models with 3 and 72 h reperfusion time. PACAP-38 levels in both atria (RA, LA) were also significantly lower than in the ischemic left ventricular samples (LV-I) (*Figure 4.*).

## IV. RESULTS

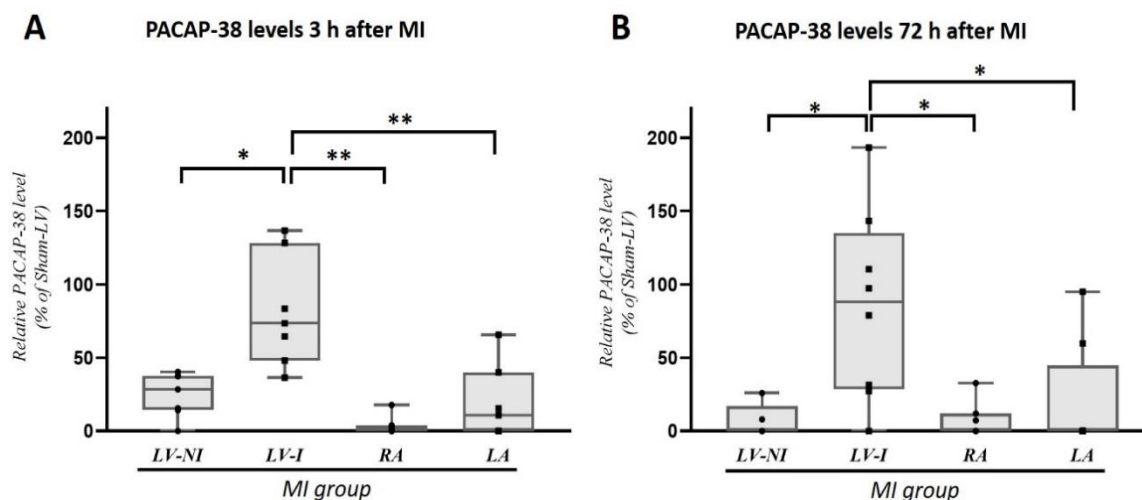

Figure 4. Comparison of the tissue PACAP-38 levels between different heart chambers and regions 3 h (A) or 72 h (B) after myocardial infarction (MI). LV-NI: non-ischemic region of the left ventricle, LV-I: ischemic region of the left ventricle, RA: right atrium, LA: left atrium. \*  $p < 0,05$ , \*\*  $p < 0.001$  vs. LV-I group.  $n=7-8$ .

Examining the potential impact of different ischemic conditioning techniques on the PACAP-38 levels (pre-, postconditioning, remote conditioning), these techniques being cardioprotective maneuvers, we did not find any differences between the three conditioning methods.

### 4.1.2. Changes of plasma PACAP-38 levels in STEMI patients

Sixteen STEMI patients (6 women, 10 men, mean age:  $60.3 \pm 2.96$  years) and 12 controls (7 women, 5 men, mean age:  $48.2 \pm 5.34$  years) were included in our human study. In the control group we included patients with the symptoms of typical or atypical chest pain without any coronary lesion. The controls underwent elective coronarography examination showing healthy coronary without any significant stenosis or plaques.

Examining the plasma PACAP levels of the STEMI patients we found significantly higher levels before PCI, during the ischemic period, and a significant decrease of the plasma PACAP levels were detected right after PCI. We found significantly higher PACAP levels in 0 h samples of the STEMI patients compared to those of the controls. Furthermore, significantly lower plasma PACAP levels were detected in STEMI patients 48 h after PCI compared to the control group (Figure 5.A). Moreover, we found a significant weak negative correlation between all the time-matched plasma PACAP and troponin levels in the STEMI patient group (Figure 5.B). However, examining the time-matched PACAP and troponin levels separately (0, 4, 24, 48 h samples) there were no significant correlations.



## IV. RESULTS

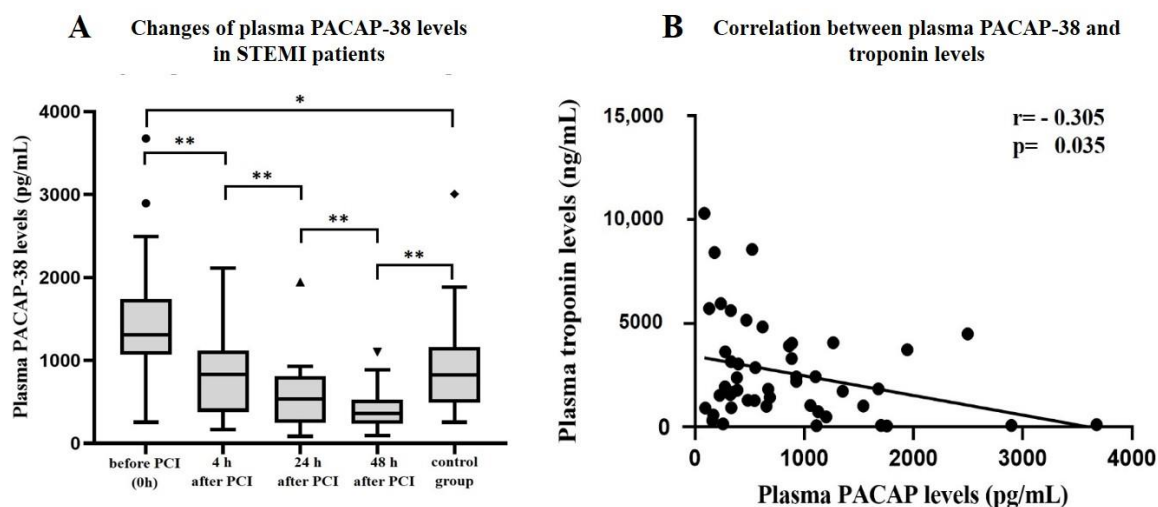

Figure 5. **A)** Changes of plasma PACAP-38 levels in STEMI patients ( $n=16$ ) and the healthy control group ( $n=12$ ). **B)** Correlation between the plasma PACAP-38 and troponin levels in STEMI patients. \*\* $p < 0.001$ , \* $p < 0.05$

Examining the potential correlation between the main risk factors of STEMI (hypertension, diabetes mellitus, hemoglobin A1c [HbA1c] levels and smoking) and the initial PACAP-38 levels, we found a significant positive correlation ( $r = 0.533$ ,  $p = 0.034$ ) between hypertension and PACAP levels. However, there was no connection between the individual effect of the other risk factors and the examined polypeptide. Moreover, multivariate analysis showed a remarkable significant additive influencing effect of hypertension and HbA1c on the PACAP levels in MI patients. In contrast, the echocardiographic and routine laboratory parameters, previous anti-ischemic medication therapy showed no significant correlation with PACAP.

### 4.2. Examination of heart failure, ischemic (ICM) and non-ischemic (NICM) cardiomyopathy

#### 4.2.1. Examination of plasma PACAP-38 levels in patients with different stages of dilated cardiomyopathy (DCM)

In our preliminary study we included 42 DCM patients (mean age:  $64,4 \pm 5,7$  years, 83,3% men, 16,7% women). Examining the potential correlation between PACAP-38 and NT-proBNP levels we did not find any significant connection in the primary DCM group. In contrast, a significant negative correlation was detected between the two examined markers in the different severity HF subgroups of ischemic DCM patients. In the group of mild HF patients (NT-proBNP < 500 pg/ml) a significant strong negative correlation ( $r = -0.573$ ,  $p = 0.021$ ) was detected. Furthermore, in moderate HF (NT-proBNP = 500-3000 pg/ml) we found a significant moderate negative correlation ( $r = -0.271$ ,  $p = 0.042$ ), till the severe HF patients showed only a

## IV. RESULTS

weak negative connection between PACAP and NT-proBNP levels. Positive correlation ( $r = -0.395$ ,  $p = 0.021$ ) was found between EF and NT-proBNP levels, while PACAP and EF showed no significant connection.

### 4.2.2. Comparative examination of PACAP-38 levels in acute, decompensated HF, chronic, compensated HF and healthy controls

Thirteen patients with acute decompensated HF (mean age:  $66.5 \pm 3.7$  years, 33% women, 77% men), 33 patients with chronic, compensated HF (mean age:  $65.9 \pm 3.8$  years, 34.3% women, 75.7% men) and 13 age- and gender-matched control without HF (mean age:  $65.8 \pm 4.0$  years, 31% women, 69% men) were examined. Significantly higher plasma PACAP-38 levels were detected in acute HF patients compared to the chronic HF patients and also to the control group. Furthermore, we detected significantly lower plasma PACAP-38 levels in the chronic HF patients compared to both acute HF group and the control group (Figure 6.).

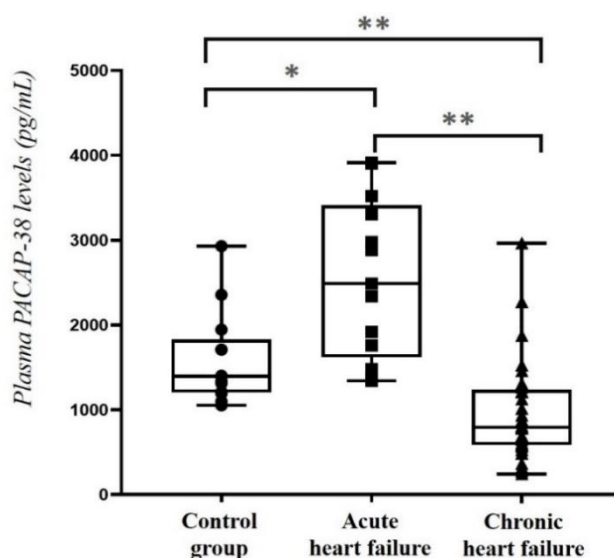

Figure 6. Plasma PACAP-38 levels in acute (decompensated) ( $n=13$ ) and chronic (compensated) ( $n=33$ ) heart failure patients compared to the control group ( $n=13$ ). \*  $p < 0.05$ , \*\*  $p < 0.001$ .

We examined the correlation between NT-proBNP, the most important prognostic marker of HF, and the PACAP-38 levels. In acute HF we did not find any significant connection between the two examined markers. On the other hand, a weak significant negative correlation ( $r = -0.271$ ,  $p = 0.042$ ) was detected in the chronic HF patients. Multivariate analysis was performed also taking the etiology of the cardiomyopathy into account (ischemic or non-ischemic) showing a positive connection between PACAP-38 and NT-proBNP in acute HF group (Figure 7A). Moreover, in chronic HF patients significantly remarkable strong negative correlation was detected between the two examined factors with multivariate analysis (Figure 7B).

## IV. RESULTS

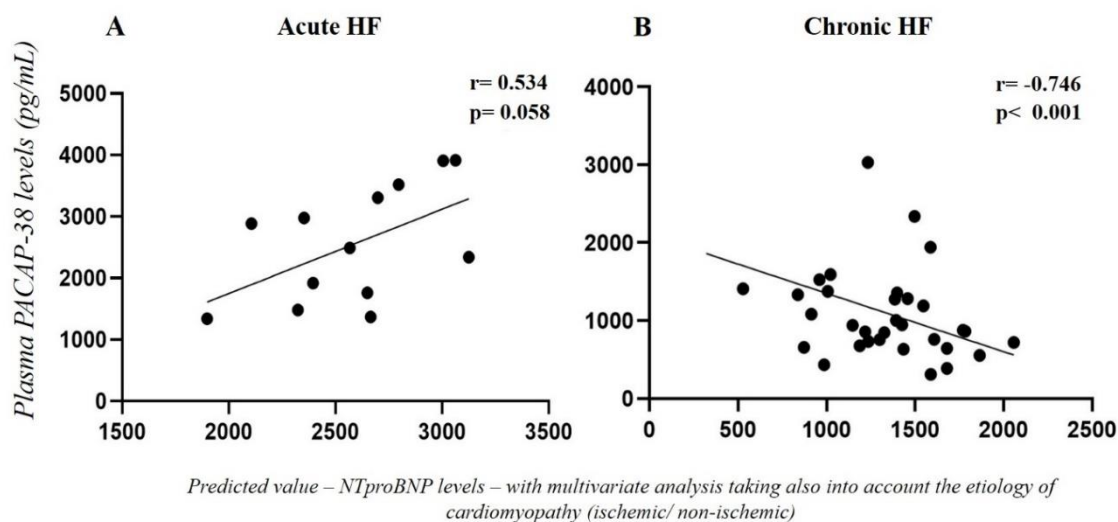

Figure 7. Correlation between the predicted value of NT-proBNP and plasma PACAP-38 levels (pg/mL) in acute (A) ( $n = 13$ ) and chronic (B) ( $n = 33$ ) heart failure (HF) with multivariate analysis also taking the etiology of cardiomyopathy into account (ischemic - ICM or non-ischemic - NICM).

To examine the potential influencing factors on plasma PACAP-38 levels – comorbidities, different medical or instrumental therapeutic opportunity, echocardiographic or routine laboratory parameters – correlation and multivariate analysis tests were performed. We did not detect any significant individual or additive effect of the examined factors on the plasma PACAP-38 levels of the HF patients. In contrast, multivariate analysis taking into account the type of HF (acute or chronic) also showed a significant strong positive correlation ( $r = 0.742$ ,  $p < 0.001$ ) between PACAP-38 and CRP.

In the HF group of 31 patients (12 acute HF, 19 chronic HF) and 9 controls we also performed a Luminex array to determine the plasma level of 7 characteristic pro- and anti-inflammatory cytokines (IL-1 $\beta$ , IL-2, IL-4, IL-6, IL-10, IFN- $\gamma$ , TNF- $\alpha$ ). In the chronic HF group significantly ( $p < 0.05$ ) lower cytokine concentrations were detected compared to both the acute HF and the control groups regarding IL-1 $\beta$ , IL-2 and IL-4 levels. In addition, significantly ( $p = 0.023$ ) higher IL-10 levels were detected in the acute HF group compared to the control, but not to the chronic HF group. In contrast, we did not detect any significant differences between the HF and control groups regarding IL-6, IFN- $\gamma$  and TNF- $\alpha$  levels.

### 4.2.3. Examination of human heart tissue samples

In the second part of the HF study we examined myocardial tissues of 23 advanced HF patients undergoing heart transplantation. The underlying diseases were non-ischemic cardiomyopathy (NICM) in 11 cases (47.8%) and ischemic (ICM) in 12 (52.2%) cases. As a control group we also included 12 healthy organ donors mostly dying of traffic accidents. Significantly higher tissue PACAP-38 levels were detected in the healthy control group compared to both the NICM and the ICM group. There was no difference between ischemic and non-ischemic cardiomyopathy patients (Figure 8).

## IV. RESULTS

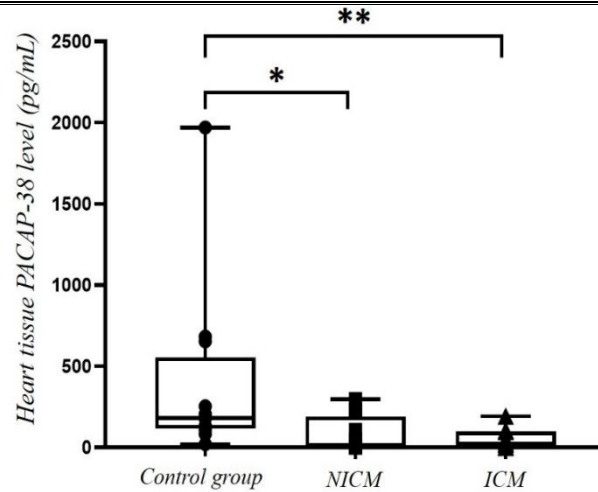

Figure 8. Tissue PACAP-38 levels in heart tissue samples from patients with non-ischemic cardiomyopathy (NICM,  $n=11$ ) or ischemic cardiomyopathy (ICM,  $n=12$ ) and from the healthy control group ( $n=12$ ). \*  $p < 0.050$ , \*\*  $p < 0.001$  vs. control group.

The correlation analysis in the examined patient groups showed no significant correlation between tissue PACAP-38 levels and NT-proBNP, as well as different echocardiographic and routine laboratory parameters.

Finally, the PAC1 receptor level was also examined with Western blot assay in the heart tissue samples of HF patients and control individuals. The densitometry analysis revealed significantly lower PAC1 receptor intensity in the tissue samples obtained from the NICM group compared to the healthy controls. In contrast, there were no significant differences in the relative PAC1 receptor intensity between the ICM and the control group (Figure 9.).

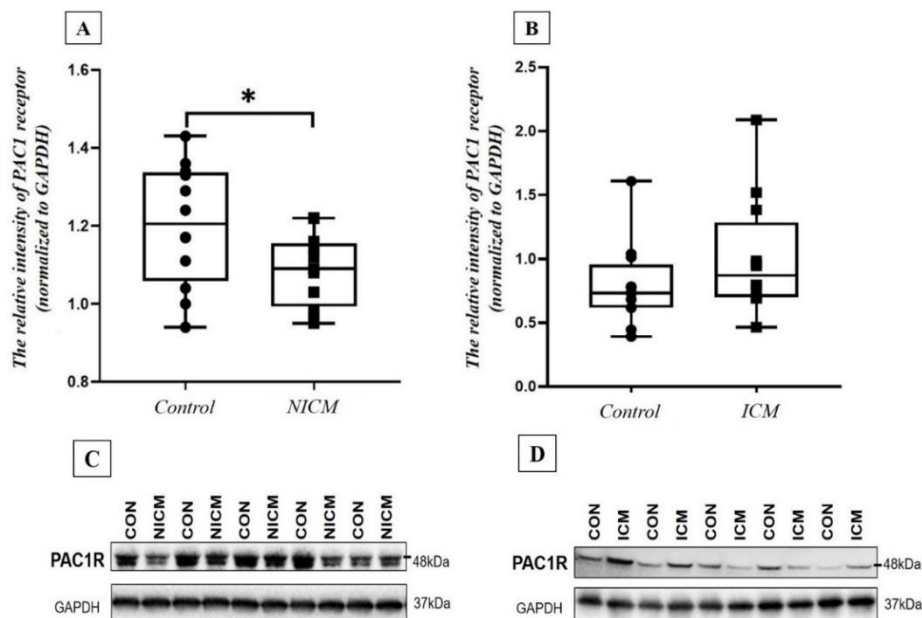

Figure 9. PAC1 receptor relative intensity in non-ischemic cardiomyopathy (A) (NICM,  $n=11$ ) and ischemic cardiomyopathy (B) (NICM –  $n=11$ , ICM –  $n=12$ ) vs. control group (CON,  $n=12$ ). C and D pictures show the scanned Western blot representative images. PAC1 receptor values are normalized to GAPDH. \*  $p < 0.05$

## V. DISCUSSION

---

The cardioprotective role of the endogenous PACAP has already been proven by several *in vitro* and animal experiments, however only few human data were recorded about these effects. In our studies we focused on two clinically relevant cardiac diseases in which PACAP may play an important role in the pathomechanism and progression.

Our study is the first translational demonstration of PACAP-38 level alterations after acute myocardial infarction and reperfusion in a porcine model and patients with STEMI. Hoover et al. detected the mRNA of PAC1 receptor in mouse heart, showing no significant regional differences between both atria and ventricles. In contrast, we detected significantly higher values in the left ventricle compared to the atrial tissues suggesting an LV-specific accumulation and/or local expression of PACAP-38. Examining the PACAP-38 level in the left ventricle of Sham and MI hearts significantly lower PACAP levels were detected in the non-ischemic regions of MI hearts (MI-LV-NI), while the ischemic regions (MI-LV-I) did not show significant differences from the Sham-LV samples. We assume that the two different MI-LV regions are not functionally independent, because of the extensive systemic effects of myocardial infarction (increased left ventricle filling pressure, increased catecholamine release, compensatory hyperkinesis of the non-ischemic regions, inflammatory and extracellular matrix processes) affecting the whole left ventricle. We suppose that the increased PACAP immunoreactivity in the cells and the extracellular matrix could compensate the decreased PACAP level, caused by the nerve injury. In addition, PACAP is a well-established modulator of the immune system and depending on the immune status, disease and age, it may exert an anti-inflammatory role in different pathological conditions. Alston et al. showed that the sympathetic innervation density is decreased in the ischemic regions of MI-LV, compared to the peri-infarct region and Sham control hearts. On the other hand, they detected increased PACAP immunoreactivity in the extracellular matrix, myocytes and macrophages in the infarct region of mouse heart. Moreover, based on the immunomodulatory effect of PACAP, we cannot exclude that ischemia/reperfusion induced injury might also trigger the local expression or deliberation/re-distribution of endogenous PACAP-38 and its receptors within the infarcted area. In our experiment, we examined homogenized heart tissue samples containing all the potential PACAP sources (macrophages, myocytes and nerve fibers), and because of the abovementioned compensatory mechanism, we did not find significant differences between the ischemic region of MI-LV compared to the Sham-LV heart samples.

In STEMI patients, plasma PACAP levels before PCI were remarkably higher compared to the healthy control group. The increased PACAP level in the plasma and tissue samples additionally could originate from the nerve fibers, cardiomyocytes and macrophages. It is also possible that the acute MI was preceded by several different ischemic attacks due to the atherosclerotic coronary arteries increasing the plasma PACAP level as the part of preconditioning. These increased PACAP levels may be a part of a cardioprotective response since it is well known that PACAP has protective effect against ischemic injury. Earlier we proved the protective effect of PACAP treatment in neonatal rat cardiomyocyte cultures against ischemia/reperfusion(I/R)-induced apoptosis. The significantly higher initial PACAP levels in AMI emphasizes the potential importance of PACAP in the pathomechanism of MI. Furthermore, the remarkably decreased PACAP concentration after 48 h may represent the

## V. DISCUSSION

---

basal level of this neuropeptide suggesting that the lower basal PACAP level may be a predictive factor for AMI. The significant negative correlation between PACAP-38 and troponin levels also confirms this theory. Moreover, the positive correlation between PACAP and hypertension also draw attention to the role of PACAP in STEMI. Multivariate analysis showed a remarkably significant positive correlation between the additive effects of hypertension and HbA1c and the PACAP levels. This result suggests that hypertension and untreated diabetes mellitus together - representing a high risk for STEMI - are related to elevated PACAP levels. The routine laboratory parameters, different previous anti-ischemic medical therapies showed no correlation with PACAP proving that these factors have no influencing effect on the plasma PACAP levels.

Based on the antiapoptotic, antioxidant, anti-inflammatory and immunomodulatory effect of PACAP it is presumable that the examined polypeptide may also have effects on the heart failure with reduced ejection fraction (HFrEF) beside the ischemic heart disease. To answer this question, we examined cardiomyopathy patients with different etiologies (ischemic or non-ischemic) detecting significant differences between the plasma PACAP-38 levels and also showing significant negative correlation between PACAP and NT-proBNP levels. Our results show that the plasma PACAP-38 levels may sensitively indicate the hemodynamic and pathophysiological changes in acute cardiac decompensation. The elevated PACAP-38 levels in acute HF can be the result of a compensating “stress response” to a suddenly worsening left ventricular ejection fraction. This reactive phenomenon seems to be a protective response, potentially decreasing acute cardiomyocyte injury. Earlier studies detected advanced cardiomyocyte injury in acute hospitalized patients with acute AF showing strong correlation with the prognosis of HF. This myocyte damage is caused by oxidative stress, apoptosis and necroptosis. PACAP effectively promotes cardiomyocytes against oxidative stress-induced apoptosis in cell culture. As a result of PACAP treatment significantly decreased caspase-3 activity and significantly higher anti-apoptotic Bcl-2 and phospho-Bad expression were identified in cultured cardiomyocyte. Furthermore, PACAP treatment significantly inhibits exacerbation of the condition in doxorubicin-induced cardiomyopathy, observing worse prognosis of HF in PACAP-deficient mice compared to wild types. According to their data, it is possible that the endogenous PACAP plays an important role in cardiomyocyte protection, and indicating that lack of PACAP indicates worse progression of HF.

The remarkable significant negative correlation between plasma PACAP-38 and NT-proBNP levels in the chronic HF group confirms our assumption that low PACAP level may be a potential biomarker for worse prognosis such as elevated NT-proBNP level. Contrarily, we detected a positive tendency in acute HF group between the two examined markers. NT-proBNP levels are usually elevated in acute decompensated HF due to the increased atrial wall strain caused by volume and pressure overload. However, the prognostic value of NT-proBNP is weaker in the acute decompensated period before treatment compared to the compensated stable chronic HF. Moreover, the positive correlation between PACAP-38 and CRP levels are also strengthening the potential biomarker role of PACAP-38 in HF. This theory is further supported by our earlier study, where we detected significant positive correlation between PACAP and CRP in poly-traumatic patients during the acute phase [23]. However, it is important to note that circulating PACAP-38 levels alone may not be a useful biomarker for

## V. DISCUSSION

---

individuals suffering from HF, therefore additional, complementary measures of other cardiac biomarkers may need to be used in combination with the polypeptide. In the future, it seems feasible that a mixed panel of multiple cardiovascular biomarkers (NT-proBNP, CRP) in one diagnostic panel will be used for the early diagnosis and reliable prediction of progression or therapeutic response in HF.

Examining the plasma cytokine levels in the different HF groups, the significantly lower IL-1 $\beta$ , IL-2 and IL-4 cytokine levels in the chronic HF group compared to both the acute HF and the control groups can be explained by the effect of the HF baseline therapy (ACEI,  $\beta$ -blocker and MRA) and the CRT-therapy. In this current study the rate of the optimal medical therapy was over 80%. Moreover, some examinations also showed that the alteration in different cytokine levels is associated with the severity of HF and the NYHA status. They found significantly higher cytokine levels in patients with more severe HF and in NYHA stage III-IV. All our chronic HF patients had compensated cardiac status with NYHA stage I-II, which might also explain the low cytokine levels, that we measured in our assays. Regarding the anti-inflammatory cytokine IL-10, we found a significantly higher cytokine level in the acute HF group compared to the controls. Moreover, there was a significant positive correlation between IL-10 and plasma PACAP-38 levels. Interestingly we did not detect any significant differences in IL-6, IFN- $\gamma$  and TNF- $\alpha$  levels between acute, chronic HF and the control groups. The results of the earlier studies are also controversial due to the different including criteria (etiology of HF, NYHA stage, baseline therapy).

In our earlier human examination, we detected higher tissue PACAP-38 levels in the patient with ischemic heart disease compared to patients with valvular disease. In this current study we examined the level of intracellular PACAP-38 levels in homogenates of NICM and ICM hearts and healthy myocardial tissues. Our present results revealed a significantly lower tissue PACAP level in the end-stage HF hearts compared to the healthy ones, which can be explained by our earlier data suggesting that intracellular PACAP-38 level or accumulation is mostly related to the living, intact cells. Based on these data we assume, that the damaged myocytes or the “exhausted” compensation mechanisms might lead to the lower tissue PACAP-38 levels that we found in end-stage HF. The latter statement is strengthened by literature data showing that the natriuretic peptide levels can be extremely low in some cases of end-stage HF due to the “exhausted” neurohormonal system making the correlation analyses more difficult. The correlation tests showed no significant correlation between the tissue PACAP levels and several routine laboratory and functional echocardiographic parameters. In summary these factors have no significant impact on the tissue PACAP levels.

In our earlier experiment we showed PAC1 receptor expression in the heart muscle cells, in contrast with the endocardial connective tissue where we did not detect PAC1 receptor positivity. To detect the potential influencing effect of the etiology of HF on the PAC1 receptor expression in this current study we examined heart tissue samples from ICM and NICM patients with end-stage HF after heart transplantation. In NICM patients significantly lower PAC1 receptor intensity was detected, while we found no significant difference in PAC1 receptor density in the ischemic group compared to the healthy controls. The possible explanation for these results is based on the different pathophysiology of the ischemic and non-ischemic cardiomyopathies. In NICM the main underlying processes are apoptosis, myocardial fibrosis

## *V. DISCUSSION – VI. CONCLUSION*

---

and consequential cardiac remodeling. We suggest that the increased cardiomyocyte apoptosis and the complex medical treatment together may lead to a decreased level of PAC1 receptors. In contrast to the above mentioned pathomechanism, both the repeated ischemic attacks and preconditioning play an important role in ICM. The ischemic preconditioning enhances the beneficial and protecting effect against ischemic injury and increases the production of various factors, such as adenosine, bradykinin or opiates. However, there are no clinical data about the connection between preconditioning and PAC1 receptor level. Based on experimental and our human study results, we hypothesized, that the relatively higher PAC1 receptor intensity is caused by the ischemic preconditioning in the ICM group. The presence of PAC1 receptors in myocardium raises the possibility of therapeutic use of endogenous or exogenous PACAP taking advantages of antiapoptotic, anti-inflammatory and antioxidant properties.

## *VI. CONCLUSION*

---

PACAP is a multifunctional neuropeptide playing an important role in the cardioprotection due to its several positive (antiapoptotic, antioxidant, anti-inflammatory) effects. In our translational study we first detected significant changes of plasma and tissue PACAP-38 levels in acute myocardial infarction. Furthermore, we found remarkable differences in the plasma and tissue PACAP-38 levels and PAC1 receptor expression in heart failure patients with different NYHA stages and etiologies compared to the healthy controls. In both (AMI and HF) patient groups significant correlations were detected between the PACAP-38 levels and the clinically most important biomarkers (hs-c Tn, NT-proBNP, CRP). All these results highlight the importance and the potential role of PACAP-38 in the different cardiovascular diseases. Even so, further human multicenter, follow-up studies are needed to assert the potential, new cardiac biomarker function of PACAP.



## VII. SUMMARY OF NEW RESULTS

---

### 7.1. Examination of acute myocardial infarction

#### *7.1.1. Examination of tissue PACAP-38 levels in porcine model of acute myocardial infarction*

- Examining the Sham-operated control group significantly higher tissue PACAP-38 levels were measured in the Sham-LV samples compared to both atria.
- We detected lower tissue PACAP-38 levels in the non-ischemic left ventricle compared to the ischemic region of MI left ventricle and also to the Sham-operated left ventricle.
- Due to the comparative examination of tissue PACAP-38 levels of the different regions of MI heart we found higher PACAP-38 levels in the ischemic left ventricle compared to both atria and also to the non-ischemic left ventricle.
- The different ischemic conditioning techniques showed no significant impact on the tissue PACAP-38 levels.

#### *7.1.2. Examination of plasma PACAP-38 levels in STEMI patients*

- Due to the examination of STEMI patients we detected higher plasma PACAP-38 levels in the first (0 h) samples before revascularization compared to the controls with healthy coronary arteries. Moreover, 4 hours after the revascularization we found significantly lower PACAP levels compared to the initial PACAP level and a significant decrease in the further 24 and 48 hours' samples. Furthermore, the plasma PACAP-38 levels 48 hours after the revascularization were also significantly lower than the healthy controls'.
- Significant negative correlation was detected between the plasma PACAP-38 and troponin levels in STEMI patients. Multivariate analysis showed significant, strong positive correlation between plasma PACAP-38 and the additive effect of two important risk factors of STEMI – hypertension and untreated diabetes mellitus. The routine laboratory parameters and the previous anti-ischemic treatments have no impact on the plasma PACAP-38 levels.

### 7.2. Examination of heart failure patients:

#### *7.2.1. Comparative examination of plasma PACAP-38 levels of different stage HF patients*

- Significant negative correlation was found between plasma PACAP-38 and NT-proBNP levels. We performed an NT-proBNP-based severity group classification detecting stronger correlation between the two markers in patients with better prognosis.
- There was no significant correlation between plasma PACAP-38 levels and the ejection fraction. Moreover, PACAP also showed no connection with the potential influencing factors (gender, age, comorbidities, laboratory parameters).

## VII. SUMMARY OF NEW RESULTS

---

### 7.2.2. Comparative examination of PACAP-38 levels in acute, decompensated and chronic, compensated heart failure patients and non-heart failure control group

- We detected significantly higher plasma PACAP-38 levels in acute decompensated HF and significantly lower PACAP-38 levels in chronic, compensated HF compared to control group.
- Examining the correlation between PACAP-38 and NT-proBNP levels we found a positive tendency in acute HF, while in chronic HF a significant negative correlation was detected. Multivariate analyses showed stronger correlation between the two examined markers – taking also into account the etiology of HF (ischemic or non-ischemic).
- The plasma PACAP-38 levels showed no significant correlation with the comorbidities, medication and pacemaker therapy and routine laboratory parameters. Thus these factors had no influencing effect on the plasma PACAP levels.
- We found significant positive correlation between the PACAP-38 and CRP levels. Multivariate analysis – taking also into account the type of heart failure (acute or chronic) showed even stronger correlation between these parameters.
- Examining the different pro- and anti-inflammatory cytokines we detected significantly lower IL-1 $\beta$ , IL-2 and IL-4 levels in chronic heart failure compared to the acute heart failure and also to the control groups. Significantly higher IL-10 levels were found in acute heart failure compared to the other two examined groups. However, we did not find any significant difference between the IL-6, IFN- $\gamma$  and TNF- $\alpha$  levels.
- Examining the connection between the plasma PACAP-38 and the different cytokine levels we detected significant positive correlation in the case of IL-1 $\beta$ , IL-2, IL-4 and IL-10.

### 7.2.3. Examination of the heart tissue samples of end-stage heart failure (ICM or NICM) patients

- Significantly higher tissue PACAP-38 levels were measured in the healthy controls compared to the ischemic or non-ischemic cardiomyopathy-caused end-stage heart failure patients.
- We did not find any correlation between the tissue PACAP-38 and the plasma NT-proBNP levels, different echocardiographic and routine laboratory parameters.
- Examining the PAC1 receptor intensity significantly lower PAC1 receptor intensity was detected in the non-ischemic cardiomyopathy group compared to the healthy controls. Meanwhile, we did not find any significant differences in the ischemic group.

## VIII. PUBLICATIONS BY THE AUTHOR

---

### Publications related to the thesis:

1. **Szabó D**, Sárszegi Zs, Polgár B, Sággy É, Németh Á, Reglődi D, Makkos A, Görbe A, Helyes Zs, Ferdinandy P, Herczeg R, Gyenesei A, Cziráki A, Tamás A. PACAP-38 in acute ST-segment elevation myocardial infarction in humans and pigs: a translational study. *Int J Molec Sci.* **2021**, 22(6), 2883. doi: 10.3390/ijms22062883. IF: 5,924, Q1
2. **Szabó D\***, Sárszegi Zs\*, Polgár B, Sággy É, Reglődi D, Tóth T, Onódi Z, Leszek P, Varga V Z, Helyes Zs, Kemény Á, Ferdinandy P, Tamás A. PACAP-38 and PAC1 receptor alterations in plasma and cardiac tissue samples of heart failure patients. *Int J Molec Sci.* **2022**, 23(7), 3715. doi: 10.3390/ijms23073715. IF: 5,924, Q1 (\*co-first authorship)
3. Sárszegi Zs, **Szabó D**, Gaszner B, Kónyi A, Reglődi D, Németh J, Lelesz B, Polgár B, Jüngling A, Tamás A. Examination of pituitary adenylate cyclase-activating polypeptide (PACAP) as a potential biomarker in heart failure patients. *J Mol Neurosci.* **2019**, 68(3), 368-376. doi:10.1007/s12031-017-1025-7. IF: 2,678, Q1.
4. **Szabó D**, Szántó Z, Jüngling A, Polgár B, Reglődi D, Cziráki A, Tamás A, Sárszegi Zs. Effects of pituitary adenylate cyclase activating polypeptide (PACAP) on the cardiovascular system. *Card Hung.* **2018**, 48; 129-135. doi:10.26430/CHUNGARICA.2018.48.2.129. - Review

*Impact factors of these publications are: 14,526*

### Publications not related to the thesis:

1. Tóth D, Szabó E, Tamás A, Juhász T, Horváth G, Fábíán E, Opper B, **Szabó D**, Maugeri G, D'Amico A. G, D'Agata V, Vicena V, Reglődi D. Protective effects of PACAP in peripheral organs. *Front Endocrinol (Lausanne).* **2020**; 11:377. doi:10.3389/fendo.2020.00377. IF: 5,55, Q1.
2. Pham D, Polgár B, Tóth T, Jüngling A, Kovács N, Balas I, Pál E, **Szabó D**, Fülöp D. B, Reglődi D, Szántó Z, Herczeg R, Gyenesei A, Tamás A. Examination of pituitary adenylate cyclase-activating polypeptide in Parkinson's disease focusing on correlations with motor symptoms. *GeroScience.* **2021**; Published: 26 February 2022. doi:10.1007/s11357-022-00530-6. IF:7,71, Q1.
3. **Szabó D**, Nagy D, Melczer Cs, Ács P, Rátgéber L, Szokodi I, Tóth M, Cziráki A, Eklics K, Sárszegi Zs. Influencing factors of cardiac adaptation in adolescent athletes. *Int J Sports Medicine.* **2021**; 42(13):1029-1221. doi:10.1055/a-1386-4805. IF: 3,12, Q1.

*Cumulative impact factor of the author: 30,906*

## *IX. ACKNOWLEDGEMENTS*

---

First of all, I would like to thank my supervisor Dr. Zsolt Sárszegi who was always a supportive stronghold and a professional tutor from the very beginning of my clinical career. I would also like to express my gratitude and sincere thanks to my researcher supervisor Dr. Andrea Tamás who provided me valuable guidance and help in my scientific work and career. Without their support and encouragement this thesis would have remained an imagination.

I am very grateful to Dr. Beáta Polgár and Prof. Dr. Zsuzsanna Helyes who always corrected and improved my scientific work with their professionalism and maximalism.

I would like to thank Prof. Dr. Dóra Reglődi, the Chair of the Anatomy Department and Prof. Dr. Attila Cziráki, the Chair of the Heart Institute for providing me the opportunity to write my thesis in their departments. It is a real privilege that I can also thank my colleagues as well as nurses, assistants and all the members of the Department of Anatomy and the Heart Institute.

I am also thankful to be given the opportunity to work with Prof. Dr. Péter Ferdinandy and all the members of the Cardiometabolic Research Group at the Pharmacology and Pharmacotherapy Department at Semmelweis University, as well as the chance to collaborate with Prof. Dr. Przemyslaw Leszek and the members of the Cardinal Stefan Wyszyński National Institute of Cardiology in Poland.

Finally, I would like to thank my dear friends and colleagues Dr. Zsófia Meiszterics and Dr. Adél Porpáczy for their constant professional and emotional support and love from the very beginning. I am also infinitely grateful to my little family and my partner for their unconditional love, constant support and sometimes the acute crisis management. Without them this thesis could not exist.

The thesis was funded by:

Hungarian Scientific Research Fund, National Research, Development and Innovation Office (NKFIH) K119759, K129190 és K135457, GINOP-2.3.2-15-2016-00050 “PEPSYS”, Hungarian Academy of Sciences MTA-TKI-14016, Thematic Excellence Program 2021 Health Sub-programme of the Ministry for Innovation and Technology in Hungary, within the framework of the EGA-16 project of the University of Pécs. Project no. TKP2021-EGA-16 has been implemented with the support provided from the National Research, Development and Innovation Fund of Hungary, financed under the TKP2021- EGA funding scheme , EFOP 3.6.1-16.2016.00004.