



PÉCSI TUDOMÁNYEGYETEM
KÖZGAZDASÁGTUDOMÁNYI KAR
GAZDÁLKODÁSTANI DOKTORI ISKOLA

Kiss Viktor Miklós

THE ENERGY SYSTEM OF PÉCS – A SIMULATION MODEL

DOKTORI ÉRTEKEZÉS

Témavezető: dr. Bugár Gyöngyi

Pécs, 2015

Content

Executive Summary.....	5
Chapter 1 - Introduction	7
Importance of energy management.....	7
Local energy management	10
Build-up of the dissertation.....	11
Chapter 2 – Theoretical background of simulation modelling	14
Chapter 3 - Literature review.....	18
Chapter 4 - Discrete-event system simulation.....	28
Chapter 5 – Selection of framework for model development	34
Chapter 6 – Model Development.....	41
Steps I. – II. Problem formulation and Setting objectives and overall project plan	41
Steps IV. – V. Data Collection and Model translation	44
General methodology.....	59
Steps VI. – VII. Verification and Validation	79
Chapter 7 – Model simulation	93
Steps VIII. – IX. Experimental design and Production runs and analysis.....	93
Chapter 8 - Results	108
Steps X. – XII. More runs and Documentation and reporting.....	108
Conclusion and further research areas	118
References	119
Appendices	129

List of Figures

Figure 1: World primary energy consumption 1989-2014	7
Figure 2: World consumption of primary energy, 2014	7
Figure 3: World GHG emissions flow chart, 2010	8
Figure 4: World CO2 emissions by fuel 1971-2012 (Mt of CO2)	9
Figure 5: Simulation Study Schematic	29
Figure 6: Steps in a simulation study	32
Figure 7: Relative heating needed.....	51
Figure 8: Adjusted relative amount of heating needed	52
Figure 9: Adjusted relative amount of heating needed - with non-heating period.....	53
Figure 10: Adjusted relative amount of heating needed - with non-heating period - with sanitary hot water	54
Figure 11: Normalized adjusted heating needed with sanitary hot water	55
Figure 12: Normalized adjusted heating needed with sanitary hot water, duration curve	55
Figure 13: Heat demand. Natural gas	56
Figure 14: Heat demand, District Heating	57
Figure 15: Heat demand Individual heating, wood.....	58
Figure 16: Electricity demand pattern, Hungary 2012.....	59
Figure 17: Distribution of electricity demand by sector, Pécs	63
Figure 18: CEM_t	65
Figure 19: CEN_t.....	65
Figure 20: EN_t	66
Figure 21: Ambient air temperature, Pécs, 2012	69
Figure 22: Solar radiation, Pécs, august 3rd-9th , 2012.....	69
Figure 23: Solar radiation, Pécs, 2012	70
Figure 24: Hypothetical heating demand division	80
Figure 25: Duration curve comparison I, 2012	83
Figure 26: Duration curve comparison II, 2012.....	84
Figure 27: Duration curve comparison III, 2012	85
Figure 28: Duration curve comparison IV, 2012	86
Figure 29: Duration curve comparison V, 2012	87
Figure 30: Duration curve comparison VI, 2012	88
Figure 31: Graphical layout of the reference model	90
Figure 32: Graphical layout of the reference model	92
Figure 33: Graphical layout of the BAU model.....	97
Figure 34: Graphical layout of the ES model	101
Figure 35: Example run	104
Figure 36: Comparison of fuel consumption of business as usual and energy strategy models	106

Figure 37: Comparison of share of energy from renewable sources in the final consumption.....	107
Figure 38: Graphical layout, district heating and electricity system.....	109
Figure 39: Graphical layout, individual heating systems	110
Figure 40: Graphical layout, transportation system.....	110
Figure 41: Comparison of renewable energy as proportion of final consumption	113
Figure 42: Flow diagram of the BAU model.....	115
Figure 43: Flow diagram of the ES model.....	116

List of Tables

Table 1: Key sources for CO2 emissions from fuel combustion in 2012	9
Table 2: Global distribution of proven reserves of fossil fuels.....	10
Table 3: Spectrum of dynamic systems	16
Table 4: Summary of the latest results in energy system modelling	21
Table 5: The simulation process according to Maria.....	29
Table 6: The simulation process according to Shannon	30
Table 7: Steps of simulation (a.).....	33
Table 8: Type of each tool reviewed a.	36
Table 9: Type of each tool reviewed b.	37
Table 10: Demand side – types of data needed	45
Table 11: Supply side – types of data needed.....	45
Table 12: Type of heating grouped by energy source	46
Table 13: Petrol and diesel fuel demand for vehicle categories	67
Table 14: Energy content of Diesel and Petrol fuels	67
Table 15: Energy Demand for Vehicle Categories (MWh)	67
Table 16: Supply side actors.....	68
Table 17: External data needed	68
Table 18: Energy content of energy sources.....	70
Table 19: Production characteristics of Hungarian electricity production units, 2012.....	72
Table 20: List of energy conversion units	73
Table 21: Pannonpower – energy conversion.....	74
Table 22: Pannonpower units, technical details	74
Table 23: Production characteristics of Hungarian electricity production units, 2012.....	75
Table 24: Hungarian system, used input, 2012.....	75
Table 25: Production characteristics of Hungarian electricity production units, 2023.....	76
Table 26: Hungarian system, used input, KWh, 2023	76
Table 27: Hungarian system, used input, 2023.....	76
Table 28: Priority of energy conversion units for the reference model	88
Table 29: Sources for validation of the Reference model	91

Table 30: Validation of the 2012 Reference model	91
Table 31: Priority of energy conversion units for the BAU model	94
Table 32: New setup for natural gas fired unit.....	95
Table 33: Updated input table (CHP units).....	96
Table 34: Priority of energy conversion units for the BAU model	98
Table 35: Change in aggregated demand values.....	99
Table 36: Comparison of fuel consumption of business as usual and energy strategy models.....	105
Table 37: Local vs. external sources of energy adjusted for consumption	106
Table 38: Comparison of consumption adjusted fuel use	107
Table 39: Validation of the 2012 Reference model	111
Table 40: Fuel input for BAU and ES models (TJ)	112
Table 41: Fuel use, adjusted for consumption	112
Table 42: Local vs. external sources of energy, adjusted for consumption	113
Table 43: Efficiency of BAU and ES models	114
Table 44: Efficiency of BAU and ES models, II.	117

Executive Summary

The global demand for energy has shown a sharp and continuous rise in the last and the current century. The readily available electricity, heating and cooling solutions and transportation have become integral parts of our everyday life. Almost 87% of the world primary energy need supplied by the three main types of fossil fuels, namely oil, natural gas and coal.

There are several positive and negative sides to supplying our energy demand with mainly fossil fuels. They are a very concentrated form of energy and are relatively easy to store. But since they are not evenly distributed on our globe, a high level of dependency can develop for the vast majority of the countries. Also, there is only a limited amount of proven reserves for oil natural gas and coal. Although predictions vary, there is a general consensus that the next century (or the last part of this century) will have to use non-fossil forms of primary energy to supply their needs. The emission of greenhouse gases from the combustion of these three types of fuels already account for over 65% of the CO₂ emission in the world, and thus one of the main contributors to climate change. In order to overcome these problems, steps have to be made quickly. There are several levels of decision making involved in the change procedure. Larger scale goals are determined by policies issued by the OECD or the European Union, and local decisions needed which should be in line with the larger scale goals. Local energy management, such as country or city sized decisions have a big impact on how we shape our future.

Local energy management decisions comprise the installation of different types of power plants or issuing policies helping to increase the efficiency of a system. Since energy systems are interconnected networks, some of these decisions have impacts which are unforeseen at the start of the implementation phase. In order for energy management decision makers to be as informed as possible, a system is needed which enables them to assess the potential impact of their decisions.

The goal of the current work is to develop such a system for the city of Pécs, which can model the energy system of the city in order to simulate the impact of potential decisions. This way energy management decisions can be analysed and compared with one another from a number of perspectives before the implementation phase.

The development of such a decision making system requires a detailed literature review, in order to understand the current state of the area, and a step by step plan. Based on the literature review it is found that a discrete-event simulation model would be the most efficient way of creating such a system. The steps of developing, running and evaluating a discrete-event simulation model are overviewed and shortly analysed. The main part of the dissertation consists of following and implementing these steps in order to reach the goal. The detailed collection, analysis and – where needed – preparation of the data is included for both the demand and the supply side of the system. The demand side consist of the three basic sectors of the city's energy system: electricity, heat and transportation. Both aggregated and the hourly values for each category are determined, occasionally with uniquely developed methods. The supply side of the system consists of the private or community energy conversion units, such as power plants, individual heating and the wide range of input fuel for these solutions. After the collection of the data, a reference model is developed and run, which lets the researcher know whether the developed model works according to intent, and whether it is suitable for simulation of hypothetical models.

Two hypothetical models are developed as an integral part of developing a decision making system. The city of Pécs issued an energy strategy in 2013 which determines several steps that need to be taken in order to make sure that the city has higher energy security, uses more renewable resources and is more energy efficient. In order for the decision makers to be able to compare the benefits and drawbacks of implementing the steps determined in the energy strategy, the hypothetical implementation is simulated and compared to a scenario where the steps are not taken.

The dissertation achieves new results by creating a functioning simulation model of a city sized system with integrating the electric, heating and transportation sector. The methods used to determine the duration curve of the district heating system is also an own contribution of the researcher. The results confirm that the implementation of the energy strategy of Pécs would increase the energy security of the city by using more renewable and local sources to meet its energy demand, but states that strictly speaking, the city would not use its resources in a more efficient way. With the newly developed simulation model practically any desired scenario can be modelled, and this way the decision makers can analyse the pros and cons of their decision without having to actually implement it.

Chapter 1 - Introduction

Importance of energy management

The demand for energy has shown a sharp and continuous rise in the last and the current century. The system that is capable of supplying such a volume of energy through different sub-systems uses a wide source of primary energy, ranging from fossil fuels to renewable sources. The current state and the recent change in demand for primary energy can be observed in the following figures:

Figure 1: World primary energy consumption 1989-2014

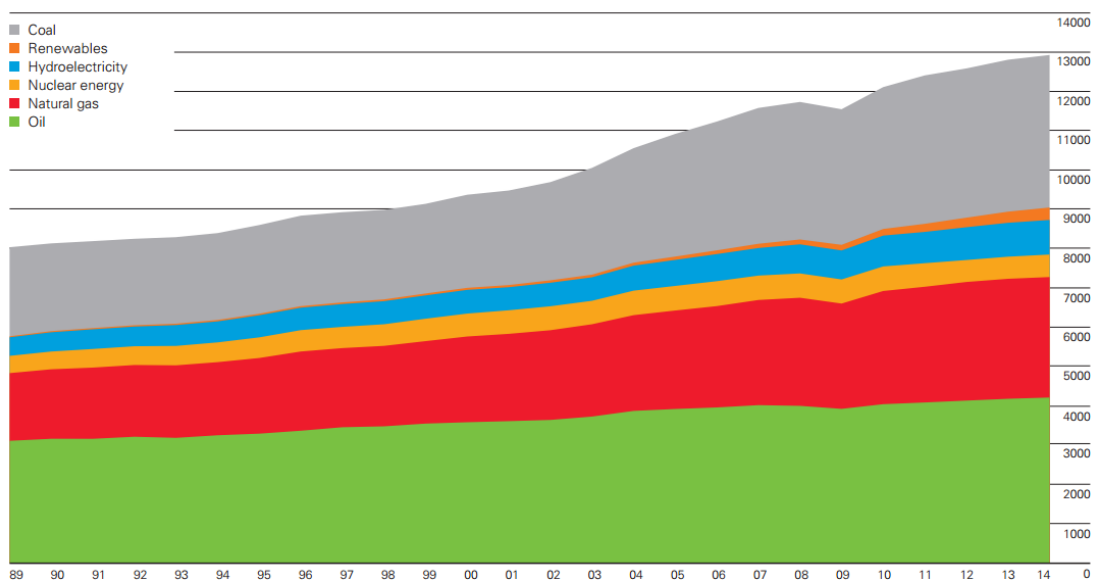

Source: BP Statistical Review of World Energy (2015)

Figure 2: World consumption of primary energy, 2014

Primary energy	Mtoe ¹	%
Oil	4130.5	33.1%
Natural Gas	2987.1	23.9%
Coal	3730.1	29.9%
Nuclear	560.4	4.5%
Hydro-electricity	831.1	6.7%
Renewables	237.4	1.9%
SUM	12476.6	100.0%

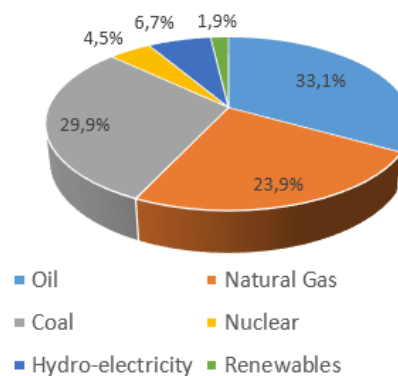

Source: Own edition, based on BP Statistical Review of World Energy (2014)

¹ Mtoe: Million tones oil equivalent

The 12,476.6 Mtoe of primary energy demand equals to 145,103 TWh². This demand is primarily supplied by fossil fuels³, such as Oil, Natural Gas and Coal (altogether 86.9%).

There are several potential dangers in using such large amount of fossil based fuels in our energy system. The burning of fossil fuels directly and indirectly lead to the anthropogenic greenhouse effect, they are not evenly distributed throughout the world, which can lead to a high degree of dependency in local energy systems, and the available amount of such fuels is limited. Greenhouse gases are those gaseous constituents of the atmosphere, both natural and anthropogenic, that absorb and emit radiation at specific wavelengths within the spectrum of thermal infrared radiation emitted by the Earth's surface, the atmosphere itself, and by clouds (IPCC, Annex II.)

The following figure (Figure 3) demonstrates the contribution of the current use of fossil fuels to the emission of greenhouse gases for 2010:

Figure 3: World GHG emissions flow chart, 2010

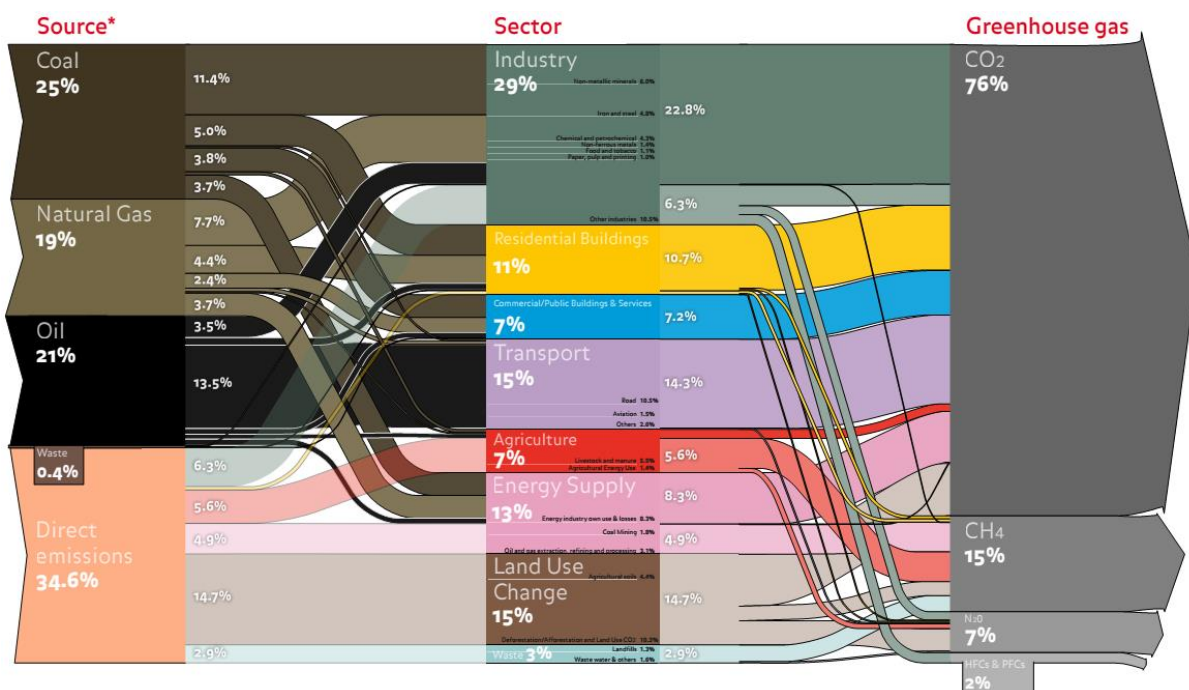

Source: www.ecofys.com, primary source of data: IEA

² TWh: Terawatt hour

³Fossil fuels: Carbon-based fuels from fossil hydrocarbon deposits, including coal, peat, oil, and natural gas (IPCC, Annex II.).

It can be seen that a large proportion of the total of 48,629 *MTCO₂ Eq.* of greenhouse gas emission is fossil fuel related emission, primarily due to the use of Coal (25%), Oil (21%) and Natural Gas (19%) (Figure 3 and 4).

According to the publication of the International Energy Agency, the amount of carbon dioxide emission from the combustion of fossil fuels is 31,734 *MT* million tonnes for 2012 (Table 1).

Figure 4: World CO₂ emissions by fuel 1971-2012 (Mt of CO₂)

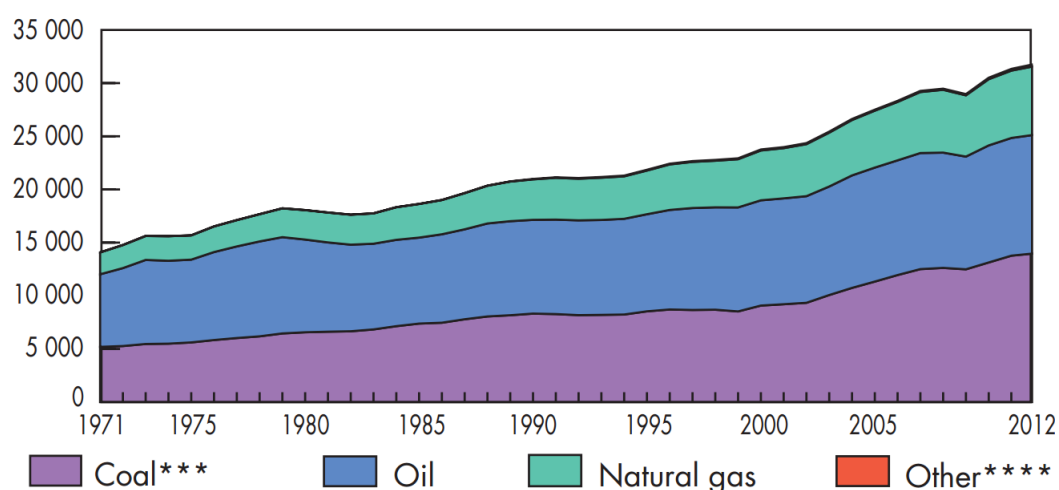

*** peat and oil shale are aggregated with coal. **** Includes industrial waste and non-renewable municipal waste.

Source: IEA (2014)

Table 1: Key sources for CO₂ emissions from fuel combustion in 2012

IPCC source category	CO ₂ emissions (MtCO ₂)	% change 90-12	Level assessment (%) ****	Cumulative total (%)
Main activity prod. elec. and heat - coal	9 031.0	98.5%	19.4	19.4
Road - oil	5 296.0	61.9%	11.4	30.9
Manufacturing industries - coal	3 516.0	58.4%	7.6	38.4
Main activity prod. elec. and heat - gas	2 287.5	121.9%	4.9	43.4
Other transport - oil	1 667.0	47.8%	3.6	46.9
Manufacturing industries - gas	1 455.6	48.1%	3.1	50.1
Manufacturing industries - oil	1 444.5	6.7%	3.1	53.2
Residential - gas	941.9	46.9%	2.0	55.2
Main activity prod. elec. and heat - oil	765.3	-25.6%	1.6	56.9
Memo: total CO₂ from fuel combustion	31 734.3	51.3%	68.3	68.3

**** Percent calculated using the total GHG estimate excluding CO₂ emissions/removals from land use change and forestry.

Source: (IEA, 2014)

The distribution of the most heavily used fossil fuels (oil, natural gas, coal) is also extremely uneven for the globe (Table 2). The Middle East owns almost half of the proven oil reserves of the globe, with Europe and Eurasia having less than 10% of it. In the case of

natural gas, the Middle East also has control of almost half of the proven reserves with Europe and Eurasia coming in second with 30.5%, although it has to be noted that 86% of those reserves are in Russia and Turkmenistan. The countries of the European Union barely own 2% of the current reserves. The global distribution of coal is a bit more evenly distributed with North America, Europe & Eurasia and Asia Pacific owning roughly even amount of it.

Table 2: Global distribution of proven reserves of fossil fuels

	Oil	Natural gas	Coal
North America	13.6%	6.3%	27.5%
Total S. & Central America	19.5%	4.1%	1.6%
Total Europe & Eurasia	8.8%	30.5%	34.8%
Total Middle East	47.9%	43.2%	3.6%
Total Africa	7.7%	7.6%	0.2%
Total Asia Pacific	2.5%	8.3%	32.3%
<u>Total World</u>	<u>100.0%</u>	<u>100.0%</u>	<u>100.0%</u>

Source: Based on BP Statistical Review of World Energy (2014)

Apart from uneven distribution fossil fuels which are sometimes owned by politically instable countries, the total remaining amount can also be a worry. Although there are several estimates on how many years of these individual fuels the globe has left, the general consensus is that it is a finite amount in each case, and an alternative to our current energy system has to be developed sooner or later.

Local energy management

In order to do that it is evident that we have to change how we manage our energy system. There are several levels of decision making involved in the change procedure. Larger scale goals determined by policies issued by OECD or the European Union, and local decisions that should be in line with the larger scale goals. Local energy management, such as country or city sized decisions can have a big impact on how we shape our future. The installation of new power plants, introduction of new energy efficiency increasing measures or the decision of introducing renewably fuelled vehicles for public transportation are only a few of the numerous decisions types which countries, or even cities can make, and do make.

Local energy management decisions can include decisions regarding the installation of different types of power plants or issuing policies helping to increase the efficiency of a system. Since energy systems are interconnected networks, some of these decisions can have

an impact which is unforeseen at the start of the implementation phase. In order for energy management decisions to be as informed as possible, a system is needed which enables decision makers to assess the potential impact of their decision on the energy system as a whole.

The state of the art method in developing these systems is modelling. Building a virtual model of a system, and running simulations can provide information which can not be obtained by simple planning.

The city of Pécs prepared its strategy to comply with sustainable development principles. A sustainable city needs a sustainable energy system and so, in 2013, the city laid its foundation for building of such a system by developing and publishing its own energy strategy. In the strategy all the requirements for a sustainable energy system are included – specifically reducing the energy dependence of the city and increasing the proportion of renewable resources within the system. The main question is: Can the implementation of the energy strategy deliver what it promises in terms of sustainability and energy security?

Build-up of the dissertation

The first chapter discusses the importance of the research topic, followed by a theoretical overlook on simulation modelling, its classifications and its potential drawbacks. The works of Bossel (1994), Maria (1997), Shannon (1998), Law and Kelton (2000) and Banks et al. (2014) are used to introduce the types of simulation methods which could be useful for the research. Difference between discrete and continuous systems, deterministic and stochastic modelling and static versus dynamic modelling is discussed.

Chapter 3 analyses simulation modelling in an extensive literature review of the area and determines the appropriate type of simulation modelling for the current research. A deterministic discrete-event simulation model is determined to be the most efficient for the goals of the research. Chapter 4 determines the steps of such a simulation. Chapter 5 identifies the right framework for the development of the simulation model with the help of Connolly et al's (2010) article: *A Review of Computer Tools for Analysing the Integration of Renewable Energy into Various Energy Systems*, which offers a deep insight into the current status of energy modelling tools.

Chapter 6 starts the simulation procedure by following the steps determined by Banks et al. (2014). Step I formulates the problem and the hypotheses, while Step II. sets the objectives and the overall project plan, which is to develop a simulation model capable of detailed analysis of the energy system of Pécs.

STEPS OF SIMULATION	
I.	Problem formulation
II.	Setting of objectives and overall project plan
III.	Model conceptualization
IV.	Data collection
V.	Model translation
VI.	Verified?
VII.	Validated?
VIII.	Experimental design
IX.	Production runs and analysis
X.	More runs?
XI.	Documentation and reporting
XII.	Implementation

Source: Based on Banks et al. (2014)

The actual model development begins in Step IV and V., which include data collection and model translation. The data collected can be grouped into two distinct categories: Demand side data and Supply side data. The demand side data consists of aggregated and hourly values for the heat, electricity and transportation sectors energy demand. The supply side of the simulation model primarily consists of the energy conversion units the city uses. This includes community solutions - such as power plants – and individual solutions such as different kinds of heating systems and photovoltaic conversion units. This chapter also includes the external data (ambient temperature and solar radiation) needed for an hourly analysis of the simulation model.

The actual simulation phase starts Steps VI. and VII. which include the verification, calibration and validation processes. The verification process checks whether the computer program used for simulation works according to the intent with the model built in. The calibration of the model consists of comparing the modelled data with actual data from the year 2012, and adjusting accordingly. The validation process analyses the input and the output values of the model, and test them against the actual input/output of the system.

After the validation of the model two experimental designs are set up in Chapter 7 (Step VIII). The two alternatives will be the 2020 energy system of Pécs, if they do not implement the specific steps determined in the energy strategy, called (BAU, business as usual), and the 2020 energy system of Pécs, if they do implement all the proposed changes (called ES – Energy Strategy). Step IX. runs the simulations and gathers the needed information from the results.

Chapter 8 includes the implementation of Steps X. through XII. and evaluates the results of the simulation of the two experimental design in terms of the research hypotheses set previously.

The appendices contain data and results on the detailed steps of the model translation phase and the emission of the evaluated energy scenarios. The model translation phase converts the information collected in the previous phase into a form that can be used by the modelling framework which helps with the analysis, while the emission analysis phase defines the type of greenhouse gases the model wishes to include and the values of each type for energy sources and energy conversion units.

Chapter 2 – Theoretical background of simulation modelling

Chapter 2 provides a discussion on the theoretical background of simulation modelling. The works of Bossel (1994), Maria (1997), Shannon (1998), Law and Kelton (2000) and Banks et al. (2014) are used to introduce the types of simulation methods which could be useful for the research. Difference between discrete and continuous systems, deterministic and stochastic modelling and static versus dynamic modelling is discussed.

Law and Kelton (2000) introduce simulation as a technique to imitate the operations of various kinds of real-world systems. A *system* is “a collection of entities, e.g., people or machines that act and interact together toward the accomplishment of some logical end” (as cited in Law and Kelton (2000, p. 3)). In order to imitate (simulate) a system, assumptions have to be made about how it works. With the help of these assumptions, a model is formulated, which can be used to answer questions about how the system behaves.

Simulation is one of the most powerful tools available to decision-makers responsible for the design and operation of complex processes and systems. It makes possible the study, analysis and evaluation of situations that would not be otherwise possible. In an increasingly competitive world, simulation has become an indispensable problem solving methodology for engineers, designers and managers (Shannon, 1998). Pegden et al. (1995) define four basic purposes for using simulation to analyse different types of systems:

- Gaining insight into the operation of a system
- Developing operating or resource policies to improve system performance
- Testing new concepts and/or systems before implementation
- Gaining information without disturbing the actual system

Simulation models created based on real life systems has been an increasingly popular method of analysis, since the use of personal computers has become widely available. The method of simulation can be used on particularly any system, so it important to determine when simulation is an appropriate tool and when it is not. Banks and Gibson (1997) give a good guideline on when it is not appropriate to use simulation as an analytical tool:

- The problem can be solved using common sense
- It can be solved analytically

- It is easier to do direct experiments on the real system
- The cost of simulation exceeds possible savings
- There aren't proper resources available for the project
- There isn't enough time for the model results to be useful
- There is no data, not even estimated ones
- The model cannot be verified or validated
- Project expectations can't be met
- System behaviour is too complex or cannot be defined.

If none of these criteria hold up, simulation can be a very useful tool for the analysis of a system if applied properly.

According to Bossel (1994), the simulation of behaviour can be achieved by two entirely different approaches. The first is *description of behaviour*, where observation takes place and the system is treated as a “black box”. This method uses mathematical relationships to connect input to output, without actually trying to understand exactly what goes on within the system. The other - more sophisticated approach - is the *explanation of behaviour*, where the emphasis is on the description of structure and processes.

Banks et al. (2014) use the following approach in their work. They state that the behaviour of a system over time can be studied by developing a simulation model. A simulation model includes the elements (or entities) of the system and the relationship between them. If the developed system acts according to initial intention then it is used to answer questions about the future behaviour of the system.

Types of simulation models

Law and Kelton (2000) classify simulation models along three different dimensions:

Static vs. Dynamic Simulation Models. A *static* simulation model is a representation of a system at a particular time, or one that may be used to represent a system in which time simply plays no role. A *dynamic* simulation model represents a system as it evolves over time.

Deterministic vs. Stochastic Simulation Models. If a simulation model does not contain any probabilistic (i.e., random) components, it is called deterministic (the output is determined once the set of input quantities and relationships in the model have been

specified). On the other hand, stochastic simulation models are known to have at least one random variable in them.

Continuous vs. Discrete Simulation Models. A discrete system is one for which the state variables⁴ change instantaneously at separated points in time. A continuous system is one for which the state variables change continuously with respect to time.

Bossel (1994) classifies dynamic systems with the help of nine categories (see Table 3). Generally, a dynamic model is best described with the characteristics in the left hand column.

Table 3: Spectrum of dynamic systems

explanatory	descriptive
real parameter	parameter fitting
deterministic	stochastic
constant parameters	time-variant parameters
non-linear	linear
time-continuous	time-discrete
space-discrete	space-continuous
autonomous	exogenously driven
numerical	non-numerical

Source: (Bossel, 1994)

The brief summary of the description of table above is as follows. The importance of explanatory models over descriptive ones was discussed on the previous page: it explains the behaviour of the system. The use of real parameters of the modelled system yields a better description of the behaviour than the fitting of parameters based on empirical observations, although the latter method is also acceptable. If no parameters change randomly, the system is deterministic. Short-term modelling usually allows for the use of constant parameters but they cannot be maintained when processes like aging play a role. Since generally linear systems (where state variables only appear in the first power) can be treated with analytical methods, simulation modelling is best used for non-linear systems.

Dynamic systems of the world tend to be continuous (measurable at any instant) opposed to time-discrete systems, where the states are only defined and observable at certain discrete time intervals. A distinction has to be made based on whether the distribution of system quantities in space is of essential importance for the simulation. Generally real

⁴ A state variable is a particular measurable property of an object or system (Choi and Kang, 2013).

systems are embedded within an environment with which they receive inputs from and also respond. But system behaviour is often dominated by its autonomous response models. The measurement of the performance of a system is more easily done if all the factors are quantifiable. However the inclusion of non-numerical state variables is now, and sometimes explicitly needed.

Banks et al. (2014) also make a distinction between discrete and continuous systems. They define discrete systems as systems in which the state variable(s) change only at a discrete set of points in time as opposed to continuous systems, where the state variable(s) change continuously over time.

Although simulation can be very advantageous it does have its potential drawbacks. Shannon (1998) lists three major issues:

- Simulation modelling is an art that requires specialized training and therefore skill levels of practitioners vary widely. The utility of the study depends upon the quality of the model and the skill of the modeller.
- Gathering highly reliable input data can be time consuming and the resulting data are sometimes highly questionable. Simulation cannot compensate for inadequate data or poor management decisions.
- Simulation models are input-output models, i.e. they yield the probable output of a system for a given input. They are therefore "run" rather than solved. They do not yield an optimal solution, rather they serve as a tool for analysis of the behaviour of a system under conditions specified by the experimenter.

Banks et al (2014) also list some potential disadvantages of simulating models based on real systems. The main points are in line with Shannon (1998), but they include the potential expensiveness of building simulation models and point out that a budget cut could easily result in a less than satisfactory model.

In the following chapter the literature review determines the characteristics of simulation models which are widely used to evaluate energy systems.

Chapter 3 - Literature review

Chapter 3 provides a detailed discussion on the current state of simulation modelling, with strong emphasis on energy systems. It evaluates the literature by analysing the state of the art publications in the area, determining a potential path for the current research.

The application of simulation models is a widely used method to assess the behaviour and the potential effects of proposed changes within an energy system. The literature review will determine the characteristics of the leading energy system analyses in order for the researcher to make a choice on the appropriate classification of the model to be developed. Several country and regional specific models have been developed with a wide variety of purposes, such as the reduction of fossil fuel use and introduction of fluctuating renewable energy sources. The detailed summary of the literature review can be found in Table 4.

The major country specific analyses of the category are the following: Lund (2006) explored the integration of large scale renewable energy source into the electricity supply, while Lund and Mathiesen (2009) modelled the Danish energy system with the proposition of 100% renewable energy. A similar work was done by Ćosić et al. (2012) on the Macedonian energy system. The potential effects of the nuclear reduction strategy of Romania was investigated by Gota et al. (2011), while Sáfián (2014) developed the model of the Hungarian energy system. Other country specific analyses include the work of Lund, H., G. Šiupšinskas, and V. Martinaitis (2005) on the implementation of small CHP-plants in Lithuania, and the research of Ben Elliston, Iain Macgill and Mark Diesendorf (2012, 2013, 2014) on the potential 100% renewable energy supply to the Australian electricity system. The analysis of reaching the carbon intensity target for Poland was researched by Budzianowski (2012). A basic modelling structure was built by Connolly et al. (2011) for the energy system of Ireland. The estimation of energy storage requirements for a future 100% renewable energy system in Japan was analysed by Esteban et al. (2012). Newest results include the analysis of different renewable energy scenarios in the Portuguese electricity system (Fernandes and Ferreira, 2014) and the modelling of the energy system of Hong Kong (Ma et al, 2014).

The current research intends to analyse a smaller region, and determines one of its goals to be the investigation of the possibility of lowering fossil fuel dependency for the city of Pécs, which is imported from outside the region. A similar approach is used by Østergaard

et al. (2010 and 2011) who aim to research the reduction of fossil fuel usage in the Aalborg Municipality and Frederikshavn through the large volume integration of low-temperature geothermal heat, wind power and biomass. The potential benefits of widespread combined heat and power based district energy network were analysed for the province of Ontario by Duquette et al. (2014). The potential effect of expanding the district heating system with heat saving is analysed by Connolly et al. (2014). The 4th generation district heating and its integration into future sustainable energy system was researched by Lund et al. (2014). System integration is not always the primary field of analysis. Lund et al. (2012, 2) also analysed the market integration of wind power in Denmark. Lund et al. (2012, 1) even researched the question of the steps that need to be taken to transform electricity smart grids into smart energy systems. Analyses investigating the district heating system supplied with cogeneration include the work of Tehrani et al. (2013), who conducted an hourly energy analysis and feasibility study of employing a thermocline TES system for an integrated CHP and DH network. Østergaard (2010) investigated the regulation strategies of CHP plants and electricity transit in Denmark.

The analysis of the energy system of an island was conducted for several islands including Hvar (Croatia) by Medic et al. (2013), Porto Santo (Portugal) by Duic and Carvalho (2004), Gökceada (Turkey) by Demiroren and Yilmaz (2009), Jeju (South Korea) by Kim et al. (2008), Malta by Busuttil et al. (2008) and Sao Vicente (Portugal) by Segurado et al. (2011).

Energy system modelling is also applied to sub-systems, smaller scaled projects and analysis of energy storage options. Hedegaard et al. (2012) analysed the possibilities to integrate wind power using individual heat pumps with the help of heat storage. A similar study was made by Østergaard (2013), where the role of compression and geothermal heat pumps in the integration of wind power was investigated. The issue of intermittency and efficiency was analysed by Blarke and Dotzauer (2011), where the optimization of cogeneration with heat pumps, fuel gas heat recovery, and intermediate cold storage was modelled. Mathiesen et al. (2012) researched the question of limiting biomass consumption for heating in 100% renewable energy systems. The analysis of different scenarios for the Australian National Electricity Market was investigated by Elliston et al. (2013).

The analysis of smaller scaled “micro” energy systems includes trying to find the optimum generation capacities of micro CHP systems in apartment complexes (Kim et al,

2010) and the modelling of a thermal energy storage system of a University Campus (Pagliarini and Rainieri, 2010).

The detailed literature review shows that leading publications in the area of energy system modelling tend to use a discrete event simulation with a time step of one hour for modelling at least city sized systems (see Table 4. column 11). The one hour time step seems to be a sweet-spot which enables the modeller to simulate the system accurately, but does not go into such details which would make the procedure extremely hard – or even impossible – to implement.

Also, the use of stochastic variables rarely dominates the leading papers. Deterministic models seem to give the researchers enough information to draw the needed conclusions.

Thus, the current research will follow the footsteps of the leading articles and develop a deterministic discrete-event simulation to model the energy system of Pécs. The following table summarizes the reviewed literature. For each article, the size of the researched area, the areas of analysis (heat, electricity, transportation), the used time step and the modelling framework is identified.

Table 4: Summary of the latest results in energy system modelling

	Author(s)	Year	Title	Journal	Size of analysed region	Name of analysed region	Electricity	Heat and/or Cooling	Transportation	Time step of analysis	Modelling framework
1	L. Hong, H. Lund, B. V. Mathiesen, B. Möller	2012	2050 pathway to an active renewable energy scenario for Jiangsu province	Energy Policy	Region	Jiangsu (China)	Yes	Yes	Yes	hourly	energyPLAN
2	I. G. Mason, S. C. Page, A. G. Williamson	2010	A 100% renewable electricity generation system for New Zealand utilising hydro, wind, geothermal and biomass resources	Energy Policy	Country	New Zealand	Yes	Yes	No	30 minutes	N/A
3	B. Cosic, G. Krajacic, N. Duic	2012	A 100% renewable energy system in the year 2050: The case of Macedonia	Energy	Country	Macedonia	Yes	Yes	Yes	hourly	energyPLAN
4	P. A. Østergaard, B. V. Mathiesen, B. Möller, H. Lund	2010	A renewable energy scenario for Aalborg Municipality based on low-temperature geothermal heat, wind power and biomass	Energy	Region	Aalborg Municipality (Denmark)	Yes	Yes	Yes	hourly	energyPLAN
5	P. A. Østergaard, H. Lund	2010	A renewable energy system in Frederikshavn using low-temperature geothermal energy for district heating	Applied Energy	City	Frederikshavn (Denmark)	Yes	Yes	Yes	hourly	energyPLAN
6	Dan-Ioan Gota, H. Lund, L. Miclea	2011	A Romanian energy system model and a nuclear reduction strategy	Energy	Country	Romania	Yes	Yes	Yes	hourly	energyPLAN
7	T. Ma, P. A. Østergaard, H. Lund, H. Yang, L. Lu	2014	An energy system model for Hong Kong in 2020	Energy	Region	Hong Kong	Yes	Yes	Yes	hourly	energyPLAN
8	A. Demiroren, U. Yilmaz	2009	Analysis of change in electric energy cost with using renewable energy sources in Gökceada, Turkey: An island example	Renewable and Sustainable Energy Reviews	Island	Gökceada (Turkey)	Yes	No	No	hourly	HOMER

	Author(s)	Year	Title	Journal	Size of analysed region	Name of analysed region	Electricity	Heat and/or Cooling	Transportation	Time step of analysis	Modelling framework
9	P. A. Østergaard	2011	Comparing electricity, heat and biogas storages' impacts on renewable energy integration	Energy	City	Aalborg (Denmark)	Yes	Yes	Yes	hourly	energyPLAN, energyPRO
10	P. S. Kwon, P. A. Østergaard	2012	Comparison of future energy scenarios for Denmark: IDA 2050, CEESA (Coherent Energy and Environmental System Analysis), and Climate Commission 2050	Energy	Country	Denmark	Yes	Yes	Yes	hourly	energyPLAN
11	A. Fragaki, A. N. Andersen	2011	Conditions for aggregation of CHP plants in the UK electricity market and exploration of plant size	Applied Energy	Country	United Kingdom	Yes	Yes	No	hourly	energyPRO
12	B. Möller, H. Lund	2010	Conversion of individual natural gas to district heating: Geographical studies of supply costs and consequences for the Danish energy system	Applied Energy	Country	Denmark	Yes	Yes	Yes	hourly	energyPLAN
13	A. Busuttil, G. Krajacic, N. Duic	2008	Energy scenarios for Malta	International Journal of Hydrogen Energy	Island	Malta	Yes	Yes	Yes	hourly	H2RES
14	H. Lund, B.V. Mathiesen	2008	Energy system analysis of 100% renewable energy systems—The case of Denmark in years 2030 and 2050	Energy	Country	Denmark	Yes	Yes	Yes	hourly	energyPLAN
15	P. A. Østergaard, H. Lund, F. Hvelplund, B. Möller, B. V. Mathiesen, A. Remmen	2010	Energy vision for Aalborg municipality 2050 (original Danish title: Energivision for Aalborg Kommune 2050)	-	City	Aalborg (Denmark)	Yes	Yes	Yes	N/A	N/A

	Author(s)	Year	Title	Journal	Size of analysed region	Name of analysed region	Electricity	Heat and/or Cooling	Transportation	Time step of analysis	Modelling framework
16	M. Esteban, Q. Zhang, A. Utama	2012	Estimation of the energy storage requirement of a future 100% renewable energy system in Japan	Energy Policy	Country	Japan	Yes	Yes	Yes	hourly	N/A
17	A. Fragaki, A. N. Andersen, D. Toke	2007	Exploration of economical sizing of gas engine and thermal store for combined heat and power plants in the UK	Energy	Country	United Kingdom	Yes	Yes	No	hourly	energyPRO
18	G. Krajacic, N. Duic, M. G. Carvalho	2010	How to achieve a 100% RES electricity supply for Portugal?	Applied Energy	Country	Portugal	Yes	No	No	hourly	H2RES
19	H. Lund, G.S. Siupsinskas, V. Martinaitis	2005	Implementation strategy for small CHP-plants in a competitive market: the case of Lithuania	Applied Energy	Country	Lithuania	Yes	Yes	No	hourly	energyPRO
20	N. Duic, M. Carvalho	2004	Increasing renewable energy sources in island energy supply: case study Porto Santo	Renewable and Sustainable Energy Reviews	Island	Porto Santo (Portugal)	Yes	No	No	hourly	H2RES
21	R. Segurado, G. Krajacic, N. Duic, L. Alves	2011	Increasing the penetration of renewable energy resources in S. Vicente, Cape Verde	Applied Energy	Island	S. Vicente (Portugal)	Yes	Yes	No	hourly	H2RES
22	I. B. Bjelic, N. Rajakovic, B. Cosic, N. Duic	2013	Increasing wind power penetration into the existing Serbian energy system	Energy	Country	Serbia	Yes	Yes	Yes	hourly	energyPLAN
23	N.A. Le, S.C. Bhattacharyya	2011	Integration of wind power into the British system in 2020	Energy	Country	United Kingdom	Yes	Yes	Yes	hourly	energyPLAN

	Author(s)	Year	Title	Journal	Size of analysed region	Name of analysed region	Electricity	Heat and/or Cooling	Transportation	Time step of analysis	Modelling framework
24	H. Lund	2006	Large-scale integration of optimal combinations of PV, wind and wave power into the electricity supply	Renewable Energy	Country	Denmark	Yes	Yes	Yes	hourly	energyPLAN
25	W. Liu, H. Lund, B. V. Mathiesen	2011	Large-scale integration of wind power into the existing Chinese energy system	Energy	Country	China	Yes	Yes	Yes	hourly	energyPLAN
26	D. Connolly, H. Lund, B. V. Mathiesen, M. Leahy	2010	Modelling the existing Irish energy-system to identify future energy costs and the maximum wind penetration feasible	Energy	Country	Ireland	Yes	Yes	Yes	hourly	energyPLAN
27	F. Safian	2014	Modelling the Hungarian energy system. The first step towards sustainable energy planning	Energy	Country	Hungary	Yes	Yes	Yes	hourly	energyPLAN
28	H. K. Kim, S. Baek, E. Park, H. J. Chang	2014	Optimal green energy management in Jeju, South Korea On-grid and off-grid electrification	Renewable Energy	Island	Jeju (South Korea)	Yes	Yes	No	hourly	HOMER
29	A. Gebremedhin	2013	Optimal utilisation of heat demand in district heating system—A case study	Renewable and Sustainable Energy Reviews	City	Unknown (Sweden)	Yes	Yes	No	N/A	Own framework, LP
30	G. Krajacic, N. Duic, Z. Zmijarevic, B. V. Mathiesen, A.A. Vucinic, M. Carvalho	2011	Planning for a 100% independent energy system based on smart energy storage for integration of renewables and CO2emissions reduction	Applied Thermal Engineering	Country	Croatia	Yes	Yes	Yes	hourly	energyPLAN, H2RES
31	P. S. Kwon, P. A. Østergaard	2013	Priority order in using biomass resources Energy systems analyses of future scenarios for Denmark	Energy	Country	Denmark	Yes	Yes	Yes	hourly	energyPLAN

	Author(s)	Year	Title	Journal	Size of analysed region	Name of analysed region	Electricity	Heat and/or Cooling	Transportation	Time step of analysis	Modelling framework
32	P. A. Østergaard	2010	Regulation strategies of cogeneration of heat and power (CHP) plants and electricity transit in Denmark	Energy	Country	Denmark	Yes	Yes	Yes	hourly	energyPLAN
33	L. Fernandes, P. Ferreira	2014	Renewable energy scenarios in the Portuguese electricity system	Energy	Country	Portugal	Yes	No	No	hourly	energyPLAN
34	B. Elliston, M. Diesendorf, I. MacGill	2012	Simulations of scenarios with 100% renewable electricity in the Australian National Electricity Market	Energy Policy	Country	Australia	Yes	No	No	hourly	Own framework
35	Z. B. Medic, B. Cosic, N. Duic	2013	Sustainability of remote communities: 100% renewable island of Hvar	J. Renewable Sustainable Energy	Island	Hvar (Croatia)	Yes	Yes	Yes	hourly	energyPLAN
36	M. Budzianowski	2012	Target for national carbon intensity of energy by 2050: A case study of Poland's energy system	Energy	Country	Poland	Yes	Yes	Yes	N/A	N/A
37	A. Hiendro, R. Kurnianto, M. Rajagukguk, Y. M. Simanjuntak, Junaidi	2013	Techno-economic analysis of photovoltaic/wind hybrid system for onshore/remote area in Indonesia	Energy	City	Temajuk (Indonesia)	Yes	No	No	hourly	HOMER
38	G. Rohani, M. Nour	2013	Techno-economical analysis of stand-alone hybrid renewable power system for Ras Musherib in United Arab Emirates	Energy	Region	Ras Musherib (United Arab Emirates)	Yes	No	No	hourly	HOMER
39	D. Connolly, H. Lund, B.V. Mathiesen, M. Leahy	2010	The first step towards a 100% renewable energy-system for Ireland	Applied Energy	Country	Ireland	Yes	Yes	Yes	hourly	energyPLAN

	Author(s)	Year	Title	Journal	Size of analysed region	Name of analysed region	Electricity	Heat and/or Cooling	Transportation	Time step of analysis	Modelling framework
40	L. Hong, H. Lund, B. Möller	2012	The importance of flexible power plant operation for Jiangsu's wind integration	Energy	Region	Jiangsu (China)	Yes	Yes	Yes	hourly	energyPLAN
41	J. Duquette , P. Wild, A. Rowe	2014	The potential benefits of widespread combined heat and power based district energy networks in the province of Ontario	Energy	Region	Ontario (Canada)	Yes	Yes	No	hourly	energyPLAN
42	M. Münster, P. E. Morthorst, H. V. Larsen, L. Bregnbæk, J. Werling, H. H. Lindboe, H. Ravn	2012	The role of district heating in the future Danish energy system	Energy	Country	Denmark	Yes	Yes	No	N/A	Balmorel
43	T. M. Weis, A. Ilinca	2007	The utility of energy storage to improve the economics of wind–diesel power plants in Canada	Renewable Energy	Region	Unknown (Canada)	Yes	No	No	hourly	HOMER
44	P. A. Østergaard	2012	Wind power integration in Aalborg Municipality using compression heat pumps and geothermal absorption heat pumps	Energy	Region	Aalborg Municipality (Denmark)	Yes	Yes	No	hourly	energyPLAN

Source: Own edition

The detailed summary of the literature review shows us that the most dominant size for energy systems modelling is the country sized analysis, although the smaller, regional, or city sized analyses can also be found. As for sectors analysed it can be seen that the electric system is always included, but for a deep analysis of systems, the spectrum of heating and cooling and transportation is also widely analysed. Due to the complexity of the analyses, often, information technology tools, so called modelling frameworks are used to speed up the process, and make the vast amount of data more manageable. EnergyPLAN seems to be the most used framework in the reviewed literature. Chapter 5 will discuss the potential choices for modelling frameworks.

The literature review also shows that a large proportion of leading energy system analyses which model at least city sized energy systems use deterministic discrete-event simulation models. The next chapter will discuss this type of modelling procedure and how to conduct a similar analysis for the purpose of the current research.

Chapter 4 - Discrete-event system simulation

As the literature review showed us, a large proportion of leading energy system analyses which model at least city sized energy systems use deterministic discrete-event simulation models. Therefore the current work will also conduct a research with the help of such a simulation model. The chapter will determine the steps of carrying out such a procedure by evaluating the proposed methods of leading books and articles of the area. The following section will discuss the similarities and differences of the literature and determine a framework for the research to follow.

Hartmut Bossel in his successful book *Modeling and Simulation* (1994) uses five basic steps to model and simulate a process.

1. Development of the model concept
2. Development of the simulation model
3. Simulation of system behaviour
4. Policy analysis and system design
5. Mathematical systems analysis

The first step's purpose is to determine simplifications and aggregations used for simplification purposes. It is also the step at which the purpose of the procedure needs to be clearly defined. The second step qualitatively describes the influence structure and specifies the relationships in a way which allows computation. The third step is the actual simulation of the developed model which includes the testing of validity. The fourth step allows for evaluating performance and the choice of policy which the researcher would like to simulate. The last step is the detailed mathematical analysis of the system and the obtained results.

Bossel's work is fundamental, but some of its steps are too general, including several procedures within one step. Anu Maria used a similar approach, but determined much more specific steps for developing and using a simulation model in 1997 in her article: *Introduction to Modeling and Simulation*. She visualizes the relationship between the real world and the simulation study the following way:

Figure 5: Simulation Study Schematic

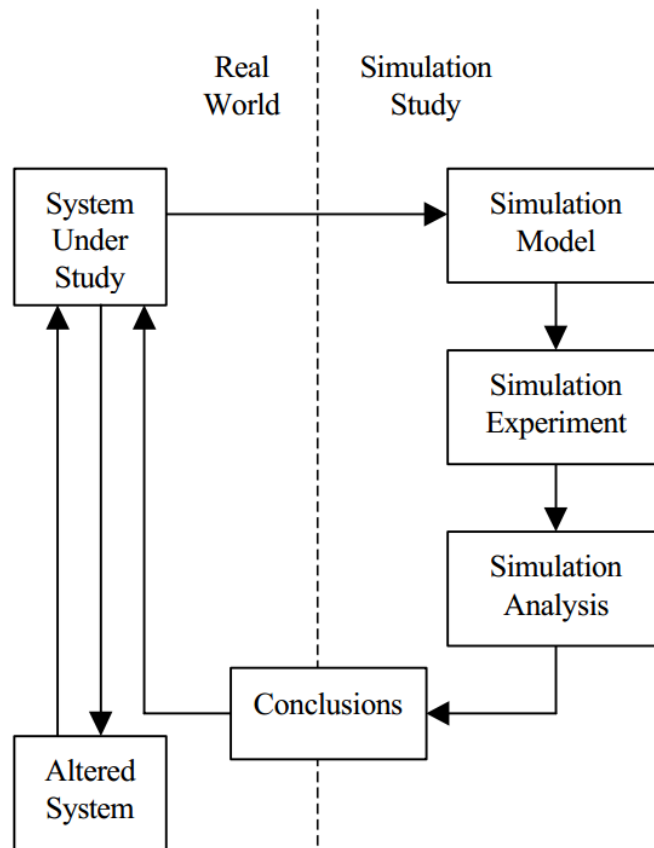

Source: Maria (1997)

She proposes eleven specific steps to conduct a simulation model study:

Table 5: The simulation process according to Maria

Step 1. Identify the problem.
Step 2. Formulate the problem.
Step 3. Collect and process real system data.
Step 4. Formulate and develop a model.
Step 5. Validate the model.
Step 6. Document model for future use.
Step 7. Select appropriate experimental design.
Step 8. Establish experimental conditions for runs.
Step 9. Perform simulation runs.
Step 10. Interpret and present results.
Step 11. Recommend further course of action.

Source: Maria (1997)

Although this – more detailed – approach permits less freedom to the modeller, it also yields a very useful guideline in developing and using a simulation model.

One of the most cited articles in discrete-event simulation is Robert E. Shannon’s work *Introduction to the Art and Science of Simulation* (1998). Although the determined steps were not unknown before, Shannon lays down some fundamentals of conducting a simulation which is widely used as a basis for research-

Table 6: The simulation process according to Shannon

1. Problem Definition. Clearly defining the goals of the study so that we know the purpose, i.e. why are we studying this problem and what questions do we hope to answer?
2. Project Planning. Being sure that we have sufficient and appropriate personnel, management support, computer hardware and software resources to do the job.
3. System Definition. Determining the boundaries and restrictions to be used in defining the system (or process) and investigating how the system works.
4. Conceptual Model Formulation. Developing a preliminary model either graphically (e.g. block diagram or process flow chart) or in pseudo-code to define the components, descriptive variables, and interactions (logic) that constitute the system.
5. Preliminary Experimental Design. Selecting the measures of effectiveness to be used, the factors to be varied, and the levels of those factors to be investigated, i.e. what data need to be gathered from the model, in what form, and to what extent.
6. Input Data preparation. Identifying and collecting the input data needed by the model.
7. Model Translation. Formulating the model in an appropriate simulation language.
8. Verification and Validation. Confirming that the model operates the way the analyst intended (debugging) and that the output of the model is believable and representative of the output of the real system.

9. Final Experimental Design. Designing an experiment that will yield the desired information and determining how each of the test runs specified in the experimental design is to be executed.
10. Experimentation. Executing the simulation to generate the desired data and to perform sensitivity analysis.
11. Analysis and Interpretation. Drawing inferences from the data generated by the simulation runs.
12. Implementation and Documentation. Reporting the results, putting the results to use, recording the findings, and documenting the model and its use.

Source: Shannon (1998)

The first eight steps in Shannon’s model is concerned with the development of a base model (sometimes referred to as a reference model), which confirms that the developed model is suitable for further research. The last four of the twelve steps is the actual intended use of the developed model where the modeller can draw conclusions for the real life system.

As it can be seen there is a uniform way with little variation of the method of conducting a simulation analysis. The work of Maria (1997) and Shannon (1998) are articles published at conference proceedings, and thus only provide the readers limited information.

Banks et al. in their book *Discrete-event System Simulation* (2014) use the aforementioned literature to develop and explain a discrete-event simulation procedure that summarizes the findings above. The steps of the simulation study process of the authors can be seen in Figure 6 and Table 7.

Figure 6: Steps in a simulation study

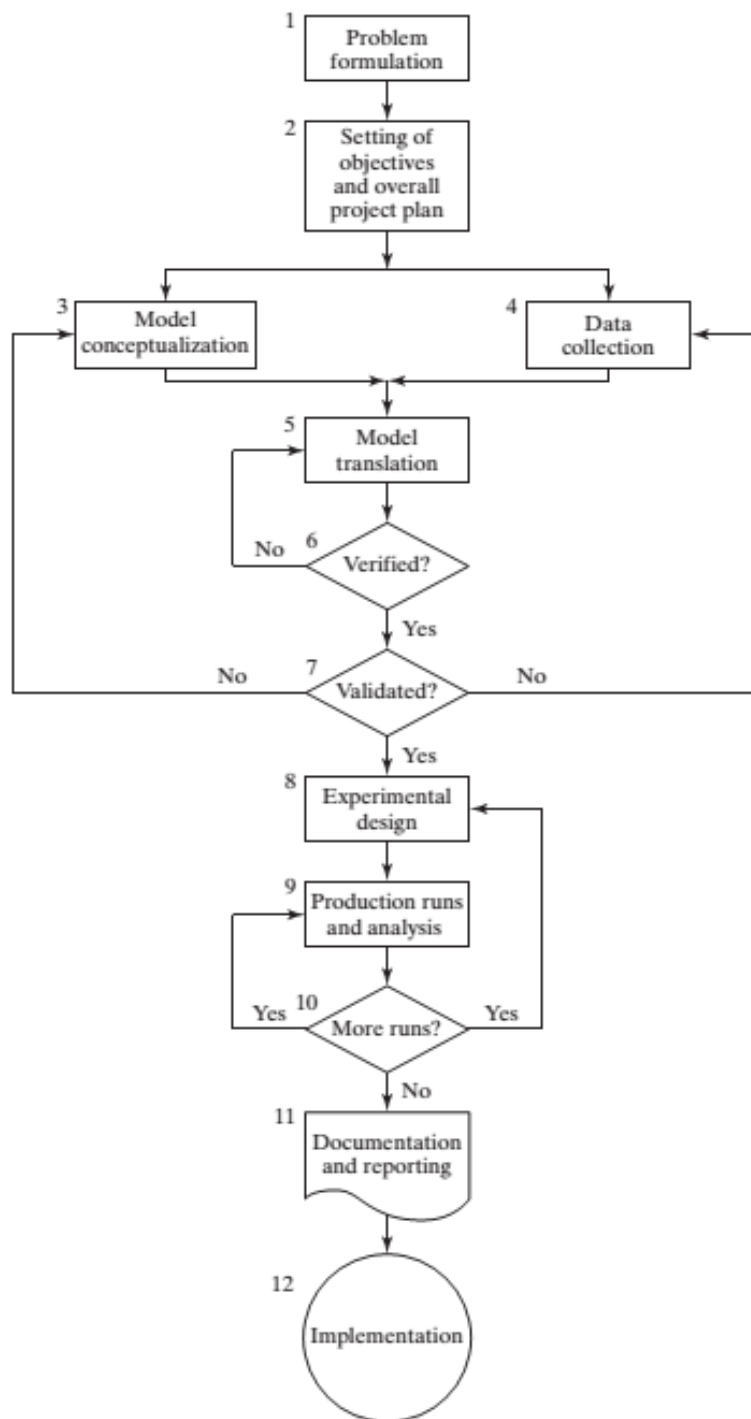

Source: Banks et al. (2014)

Table 7: Steps of simulation (a.)

STEPS OF SIMULATION

I.	Problem formulation
II.	Setting of objectives and overall project plan
III.	Model conceptualization
IV.	Data collection
V.	Model translation
VI.	Verified?
VII.	Validated?
VIII.	Experimental design
IX.	Production runs and analysis
X.	More runs?
XI.	Documentation and reporting
XII.	Implementation

Source: Banks et al. (2014)

The procedure developed by Banks et al. (2014) lists twelve specific steps with detailed instructions and explanation. The first three steps are concerned with the formulation and conceptualization of the model giving it a solid theoretical background. Steps four and five instruct the researcher to collect the needed data for the conceptualized model and make it possible for it to be used in the simulation process. The next two steps are concerned with the model truly representing what it is intended and for it to be punctual enough for conducting future studies. After validating the model the experimental design can be fed to the model and the runs and analyses may begin. If needed, more runs can be conducted. After documentation the implementation phase can try to make the best of the modellers work.

Due to the comprehensive and detailed nature of their work, and the fact that they have taken into account all the relevant literature in discrete-event simulation while developing their work, the steps of the current research will be based upon the steps determined by them.

The following chapter chooses a modelling framework that is suitable for the current research.

Chapter 5 – Selection of framework for model development

Chapter 5 identifies the right framework for the development of the simulation model with the help of Connolly et al.'s (2010) article: A Review of Computer Tools for Analysing the Integration of Renewable Energy into Various Energy Systems, which offers a deep insight into the current status of energy modelling tools.

In order to choose from the wide range of modelling frameworks, the specific energy system to be modelled has to be analysed. The goal of our current research is to develop an energy system for Pécs that meets the criteria below.

Binding criteria:

1. Capable of detailed analysis of agents of the energy system.
2. Capable of analysing a city sized system
3. Capable of covering the electricity and heat sector simultaneously for at least a one year period of time, with a time step of maximum of one hour.

Non-binding criteria:

1. Capable of investment optimization analysis (for future research purposes)
2. Capable of modelling the transportation sector

For those goals to be reached, the type of analysis has to be determined. Using classification methods from (Beeck, 1999)

- geographical coverage will be local/regional, for the area of the city
- sectorial coverage will include the electricity sector, the heat sector and preferably the transportation sector
- time horizon will cover a specific year with the time step of one hour

After identifying these points, the proper analytical framework has to be chosen. The method of choosing the right tool will be executed by taking the following classification categories one by one and eliminating tools that are not suitable for the simulation.

1. Fit in *type of tool*
2. Fit in *energy-sector considered*
3. Fit in *geographical area*
4. Fit in *time-step*
5. Fit in *scenario timeframe*
6. *Non-binding criteria*

1. Fit in type of tool

There is a wide range of tools with different approaches to the subject. Connolly et al. (2010) identifies seven different tool types:

1. A **simulation** tool simulates the operation of a given energy-system to supply a given set of energy demands. Typically a simulation tool is operated in hourly time-steps over a one-year time-period.
2. A **scenario** tool usually combines a series of years into a long-term scenario. Typically scenario tools function in time-steps of 1 year and combine such annual results into a scenario of typically 20–50 years.
3. An **equilibrium** tool seeks to explain the behaviour of supply, demand, and prices in a whole economy or part of an economy (general or partial) with several or many markets.
4. A **top-down** tool is a macroeconomic tool using general macroeconomic data to determine growth in energy prices and demands.
5. A **bottom-up** tool identifies and analyses the specific energy technologies and thereby identifies investment options and alternatives.
6. **Operation optimisation** tools optimise the operation of a given energy-system.
7. **Investment optimisation** tools optimise the investments in an energy-system.

Carefully examining the seven types listed, the most fitting type will be a simulation tool with operation optimization. The bottom up tool identifies and analyses the specific energy technologies, the *simulation tool* was chosen since for our current research, hourly time steps for a shorter period of time (e.g. one year) are fitting. The *operation optimization* feature is especially important for binding criteria 1. Also, for future studies, it would be ideal if *investment optimization* would also be a feature, although it is not essential for the current study. A time-step of at least one hour is needed, since the detailed operation of different energy conversion systems need to be analysed. A scenario timeframe of at least one year is

needed, but for further studies, several years would be ideal. A modelling framework that meets these criteria has to be chosen.

Table 8: Type of each tool reviewed, a

Tool	Type						
	Simulation	Scenario	Equilibrium	Top-down	Bottom-up	Operation optimisation	Investment optimisation
AEOLIUS	Yes	-	-	-	Yes	-	-
BALMOREL	Yes	Yes	Partial	-	Yes	Yes	Yes
BCHP Screening Tool	Yes	-	-	-	Yes	Yes	-
COMPOSE	-	-	-	-	Yes	Yes	Yes
E4cast	-	Yes	Yes	-	Yes	-	Yes
EMCAS	Yes	Yes	-	-	Yes	-	Yes
EMINENT	-	Yes	-	-	Yes	-	-
EMPS	-	-	-	-	-	Yes	-
EnergyPLAN	Yes	Yes	-	-	Yes	Yes	Yes
energyPRO	Yes	Yes	-	-	-	Yes	Yes
ENPEP-BALANCE	-	Yes	Yes	Yes	-	-	-
GTMax	Yes	-	-	-	-	Yes	-
H2RES	Yes	Yes	-	-	Yes	Yes	-
HOMER	Yes	-	-	-	Yes	Yes	Yes
HYDROGEMS	-	Yes	-	-	-	-	-
IKARUS	-	Yes	-	-	Yes	-	Yes
INFORSE	-	Yes	-	-	-	-	-
Invert	Yes	Yes	-	-	Yes	-	Yes
LEAP	Yes	Yes	-	Yes	Yes	-	-
MARKAL/TIMES	-	Yes	Yes	Partly	Yes	-	Yes
Mesap PlaNet	-	Yes	-	-	Yes	-	-
MESSAGE	-	Yes	Partial	-	Yes	Yes	Yes
MiniCAM	Yes	Yes	Partial	Yes	Yes	-	-
NEMS	-	Yes	Yes	-	-	-	-
ORCED	Yes	Yes	Yes	-	Yes	Yes	Yes
PERSEUS	-	Yes	Yes	-	Yes	-	Yes
PRIMES	-	-	Yes	-	-	-	-
ProdRisk	Yes	-	-	-	-	Yes	Yes
RAMSES	Yes	-	-	-	Yes	Yes	-
RETScreen	-	Yes	-	-	Yes	-	Yes
SimREN	-	-	-	-	-	-	-
SIVAEI	-	-	-	-	-	-	-
STREAM	Yes	-	-	-	-	-	-
TRNSYS16	Yes	Yes	-	-	Yes	Yes	Yes
UniSyD3.0	-	Yes	Yes	-	Yes	-	-
WASP	Yes	-	-	-	-	-	Yes
WILMAR Planning Tool	Yes	-	-	-	-	Yes	-

Source: Connolly et al. (2010)

Our aim is to find a tool that has the following two features: Simulation, Operation Optimization. Investment Optimization is not considered at the moment as binding criteria. Narrowing down the list of potential candidates remaining modelling frameworks that can come into consideration are (see Table 8.):

- BALMOREL
- BCHP
- EnergyPLAN
- energyPRO
- GTMax
- H2Res
- HOMER
- ORCED
- ProdRisk
- RAMSES
- TRNSYS16
- WILMAR

2. Fit in energy-sectors considered

Sectorial coverage will need to cover the electricity sector, the heat sector and preferably the transportation sector. BCHP, ProdRisk and ORCED did not qualify for this criterion; since they do not have the ability to simulate the electricity *and* the heat sector (see Table 9).

Table 9: Type of each tool reviewed, b

Tool	Energy-sectors considered			Renewable-energy penetrations simulated	
	Electricity sector	Heat sector	Transport sector	100% electricity simulated	100% renewable energy-system
Reports available detailing these renewable-energy penetrations					
EnergyPLAN	Yes	Yes	Yes	Yes	Yes
INFORSE	Yes	Yes	Yes	Yes	Yes
Mesap PlaNet	Yes	Yes	Yes	Yes	Yes
H2RES	Yes	Yes	Partly	Yes	Yes
SimREN	Yes	Yes	Partly	Yes	Yes
energyPRO	Yes	Partly	-	Yes	Partly ^a
HOMER	Yes	Yes	-	Yes	Partly ^a
TRNSYS16	Yes	Yes	-	Yes	Partly ^a
PERSEUS	Yes	Yes	Partly	Yes	-
MESSAGE	Yes	Yes	Yes	-	-
NEMS	Yes	Yes	Yes	-	-
Reports NOT available detailing these renewable-energy penetrations					
LEAP	Yes	Yes	Yes	Yes	Yes
Invert	Yes	Yes	Partly	Yes	Yes
EMPS	Yes	-	-	Yes	Partly ^a
ProdRisk	Yes	-	-	Yes	Partly ^a
RETScreen	Yes	Yes	-	Yes	Partly ^a
MiniCAM	Yes	Partly	Yes	Yes	-
SIVAEI	Yes	Partly	-	Yes	-
COMPOSE	Yes	Yes	Yes	-	-
ENPEP-BALANCE	Yes	Yes	Yes	-	-
IKARIUS	Yes	Yes	Yes	-	-
MARKAL/TIMES	Yes	Yes	Yes	-	-
PRIMES	Yes	Yes	Yes	-	-
E4cast	Yes	Yes	Partly	-	-
STREAM	Yes	Yes	Partly	-	-
EMINENT	Yes	Yes	-	-	-
UniSyD3.0	Yes	Partly	Yes	-	-
WILMAR Planning Tool	Yes	Partly	Partly	-	-
BALMOREL	Yes	Partly	-	-	-
GTMax	Yes	Partly	-	-	-
RAMSES	Yes	Partly	-	-	-
HYDROGEMS	Yes	-	-	-	-
ORCED	Yes	-	Partly	-	-
EMCAS	Yes	-	Partly	-	-
WASP	Yes	-	-	-	-
AEOLIUS	Yes	-	-	-	-
BCHP Screening Tool	-	-	-	-	-

^a Have simulated a 100% renewable-energy penetration in all the sectors they consider.

Source: (Connolly et al, 2010)

The remaining candidates are the following:

- BALMOREL
- EnergyPLAN
- energyPRO
- GTMax
- H2Res
- HOMER
- RAMSES
- TRNSYS16
- WILMAR

3. Fit in geographical area

BALMOREL, RAMSES and WILMAR are designed for International areas, whilst H2RES is for island operations. None of those comply with the current and future plans of this research. The remaining candidates are the following:

- EnergyPLAN
- energyPRO
- GTMax
- HOMER
- TRNSYS16

4. Fit in time-step

All of the remaining candidates are capable of at least hourly time step that was predetermined.

5. Fit in scenario timeframe

For scenario time frame, all remaining modelling frameworks meet the minimum criteria of the one year modelling period, but only energyPRO, GTMax and TRNSYS16 have the built in ability to analyse multiple years⁵

6. Non-binding criteria

The remaining five (EnergyPLAN, energyPRO, GTMax, HOMER, TRNSYS16) all seem to fit our goals. Since only one tool can be used for our current research, the numbers can be further reduced by applying non-binding criteria, such as the aforementioned Investment Optimization capability, which eliminates GTMax. The remaining four modelling framework were examined thoroughly in order to determine which one should be used. The next non-binding criterion was the ability to model the transportation sector, which – as a built in function - only EnergyPLAN was able to do. After examination of the other modelling framework it was found that with minor modification, energyPRO can also be fitting to our current research with regard to transportation.

⁵ Although it is possible to simulate more years with the other modelling framework by combining multiple years.

Decision

After thorough examination and testing of both (EnergyPLAN and EnergyPRO) modelling framework (full or demo version), it was found that energyPRO is capable of more detailed analysis of energy conversion units, so it was selected for the current project.

The main reasons for choosing energyPRO was that it is capable of simulation and operation optimization, suitable to analyse a smaller city sized energy system and is able to analyse with the appropriate time step and time horizon for the current research (one hour and one year). It is also capable of calculating investment and operation income/cost data which the researcher plans to use in the future analyses of the energy system. EnergyPRO is a deterministic input/output tool that is able to analyse energy systems on a very detailed level, potentially analyzing every single energy conversion unit individually. It is able to deal with different sized energy systems in great detail.

Several studies have been carried out with the help of energyPRO. Østergaard (2012) analysed the impacts of electricity, heat and biogas storages on renewable energy integration with the help of the modelling framework. Fragaki and Andersen (2011, 2012) used energyPRO to analyse whether CHP plants with thermal stores could be suitable for sustainable energy production and the accommodation of fluctuating renewable energy sources. They also explored the economic sizing of gas engines and thermal storages for CHP and power. In Denmark, most CHP plants have been designed with the help of energyPRO, and it has also been used in developing an implementation strategy for small CHP plants in Lithuania (Lund et al, 2005). The modelling framework can also be used for analysis of energy savings for buildings. Nielsen and Möller (2012) explored the energy efficiency measures in net zero energy buildings.

Although EnergyPRO is not primarily designed to simulate the transportation sector, by modelling the vehicles as energy conversion units with a negligible amount of electricity production, the modelling framework will be used to analyse every detail connected to the sector, potentially including investments and emission data. This is important for future analyses of the developed model⁶.

⁶ Anders N. Andersen, the Head of the Energy Systems Department at EMD International A/S is responsible for the development of energyPRO. He was very generous to grant a license for the duration of the current research.

A unique input structure was developed to ease the transition of data calculated outside the limits of the modelling framework. In order to be able to use the developed input structure for the analysis of any year, an 8760 hour dataset is used, which yields a 0.27% difference in the aggregated data for leap years.

Chapter 6 – Model Development

The model development chapter will consist of the problem formulation, determination of the hypotheses and the development of a reference model, which will be used for validation purposes.

Table 7. from Chapter 4 (Banks et al: Steps of simulation) will be used as a reference at the beginning of each modelling step. The current chapter will include steps I through VII.

STEPS OF SIMULATION (A.)

I.	Problem formulation
II.	Setting of objectives and overall project plan
III.	Model conceptualization
IV.	Data collection
V.	Model translation
VI.	Verified?
VII.	Validated?
VIII.	Experimental design
IX.	Production runs and analysis
X.	More runs?
XI.	Documentation and reporting
XII.	Implementation

Steps I. – II. Problem formulation and Setting objectives and overall project plan

Problem formulation, Hypotheses:

The city of Pécs prepared its energy strategy to comply with sustainable development principles. A sustainable city needs a sustainable energy system and so, in 2013, the city laid its foundation for the building of such a system by developing and publishing its own energy strategy. Included in the strategy are all the requirements for a sustainable energy system – specifically reducing the energy dependence of the city and increasing the proportion of renewable resources within the system. The main question of the decision makers: Can the implementation of the energy strategy deliver what it promises in terms of sustainability and energy security?

The developed simulation model is used and analysed as the energy system for Pécs. This analysis evaluates the proposals of the city's energy strategy and compares it to a

scenario when the proposals are not implemented. The comparison is for energy security and energy efficiency. Energy security will be evaluated by the proportion of renewable sources in the system and the proportion of locally sourced resources in the final consumption. Energy efficiency will be evaluated by the useful output of the energy system and the amount of input it uses. This model can serve as a tool for decision makers, since there are different pathways a city can take, each having its own advantages and drawbacks. The careful evaluation of how the system will behave before actual implementation enables the decision makers to consider several scenarios of development, and make an informed decision.

In order to analyse any energy system in detail, a validated model needs to be developed which is suitable to conduct further analysis. However, the development of such a model is a complex task and is rarely done for city sized areas for all the three basic areas of energy (electricity, heat and transportation).

H1: It is possible to design a model of Pécs which incorporates the three basic areas of energy (electricity, heat and transportation) and is capable of simulating real life events.

The question whether the actual implementation of the proposed steps of the city's energy strategy would fulfil the expectations regarding the energy security and energy efficiency are essential.

H2: The implementation of the proposed energy strategy of Pécs would increase the energy security of the city.

Whether the energy demand of a city can be fulfilled depends on many factors. The higher degree a city (or and sized energy system for that matter) has control over the energy sources it uses decreases the probability of a situation where there is an energy shortage. Renewable and local energy sources are generally uninfluenced by external factors, as opposed to non-renewable sources, of which there can be a shortage of and their supply does not solely depend on the city's actions.

H3: The implementation of the proposed energy strategy of Pécs would increase the efficiency of the energy supply for the city.

The definition used for determining the energy efficiency of an energy system is the following: "Using less energy to produce greater economic output. It can be expressed as a ratio of useful outputs to energy inputs for a system." (Lovins, 1977; Ming and Xin, 2015) An

increase in the efficiency would in this case practically mean that the newly developed energy system would be capable of supplying a unit of energy from fewer resources.

Setting of objectives and overall project plan

The primary goal of the dissertation is to develop a simulation model (suitable for detailed analysis) of an energy system for a city covering heat, electricity and transportation, together with a wide range of energy conversion possibilities in order to provide the necessary information for decision makers. Developing a simulation model would make the analysis of several types of changes possible, with regard to interconnectivity between the different sub-systems.

Boundaries of the model

The research focuses on the three basic areas of electricity, heat and transportation. It does not intend to analyse any other area connected to energy use. It is a discrete-event simulation with a deterministic input-output data structure. It optimizes operation through allocation of resources in order to serve pre-determined energy demand. The simulation uses one hour time steps for the duration of one year at a time. The time step of one hour is widely accepted in the leading literature as a sufficient time step for such modelling purposes. The model works with data on an “as is” basis. Although huge efforts are made to make sure that input data are accurate and realistic, the main purpose of the research is to develop a framework where potential decisions can be simulated. The developed simulation model will also be able to analyse the emissions connected to the operation of the system. The specific values for each type of emission needs careful and detailed research for the specific technologies and fuel types used in the energy system of Pécs. Although there are emission data presented and analysed in the in appendix II., this is strictly for representing that the developed model is capable of this type of analysis. The accurate representation of emission data is a field for further research, and is out of scope for the current work. Any data set where the quality turns out to be less than satisfactory can be changed later, since the model is developed to be able to handle it.

The model is run for each hour of a year. The modelling framework is set to supply all energy demand (electricity, heat and transportation) from the available energy conversion units. If two or more energy conversion unit is capable of supplying a given demand (for example solar and natural gas heating for individual buildings, or biomass or natural gas fired

CHP units for the district heating system) the priority will always be given to the renewable energy solution.

The next chapter will systematically collect the data needed for the development of the simulation model. It will take into consideration both the supply and the demand side of the energy system with respect to electricity, heat and transportation sectors.

Steps IV. – V. Data Collection and Model translation

STEPS OF SIMULATION (A.)	
I.	Problem formulation
II.	Setting of objectives and overall project plan
III.	Model conceptualization
IV.	Data collection
V.	Model translation
VI.	Verified?
VII.	Validated?
VIII.	Experimental design
IX.	Production runs and analysis
X.	More runs?
XI.	Documentation and reporting
XII.	Implementation

As it can be seen in Figure 6 (Steps in a simulation study), after step II. (setting of objectives and overall project plan) steps III. or IV. (model conceptualization or data collection) need to be made. Since all the studies in the literature used data collection to create their models, this will be the choice for the current research.

Data collection and preparation⁷

The data collection phase will gather information from a wide variety of resources. It will include both the demand and the supply side of the system with respect to electricity heat and transportation. For some areas the needed data is readily available, such as the aggregated energy demand values of the city. For some areas needed to develop a working simulation model the information is not available and has to be developed from different data sources. A prime example is the hourly distribution of the heat demand. The aggregated data is not sufficient for the type of simulation that needs a value for each hour of the modelled time period. To solve this problem, an own method is developed, where the hourly distribution of

⁷ The data collection will include data for all current and future systems that the research will analyse.

the heat demand is constructed with the help of the aggregated demand and ambient temperature values.

The data needed for the simulation process will be classified into two groups: Demand side data and *Supply* side data. The following tables specify the nature of the data needed:

Table 10: Demand side – types of data needed

	DEMAND SIDE	AGGREGATED	HOURLY VALUES
HEAT	Natural Gas	<input checked="" type="checkbox"/>	<input checked="" type="checkbox"/>
	District heating	<input checked="" type="checkbox"/>	<input checked="" type="checkbox"/>
	Firewood, other	<input checked="" type="checkbox"/>	<input checked="" type="checkbox"/>
	ELECTRICITY	<input checked="" type="checkbox"/>	<input checked="" type="checkbox"/>
	TRANSPORTATION	<input checked="" type="checkbox"/>	<input checked="" type="checkbox"/>

Source: Own edition

Table 11: Supply side – types of data needed

SUPPLY SIDE			
	E-content		
ENERGY SOURCES	<input checked="" type="checkbox"/>		
	Type of input(s)	Type of output(s)	Efficiency
ENERGY CONVERSION UNITS	<input checked="" type="checkbox"/>	<input checked="" type="checkbox"/>	<input checked="" type="checkbox"/>

Source: Own edition

Demand side

For the modelling of the three sub-systems of the energy system of Pécs, the energy demand is needed for heat, electricity and transportation. In the current chapter, each category will be discussed in detail. If not stated otherwise, the data are for 2012.

Heat

The heat demand of Pécs consists of three major factors: District heating, natural gas fired heating (District heating + individual heating⁸) and individual biomass (wood/woodchip) heating. The first two solutions account for serving 85% of the heat demand, while the

⁸ Please note that some industry users are in the individual heating group. The current research does not wish to distinguish a separate group for them.

remaining demand is primarily served by firewood (Strat). The aggregated values are the following:

Table 12: Type of heating grouped by energy source

Type of heating / energy source	<i>TJ</i>
Natural Gas	1,844
District heat	1,266
Firewood, other	556

Source: Energy Strategy of Pécs (2013)

The distribution of the aggregated data among the 8760 hours of the modelled year will be determined by the methodology developed in the following section.

Determining the distribution of heat demand based on external heat values

For each of the heating methods discussed in this chapter, an identical normalized duration curve will be used. To determine the load curve, a calculation method using the external air temperature values is developed. This method can be used for arbitrary length time steps, and an arbitrary time horizon. Please note, that in order to use this method, an external air temperature value is needed for each time step.

Let t denote the time step, and T the number of time steps within the examined time horizon.

Assuming that the district heating needs to be turned on when the air temperature cools down to a certain point, and the spaces are heated up to a certain temperature, the *relative⁹ amount of heating needed* for each hour can be determined the following way:

For time steps, where $A_e < A_s$,

$$RH_t = A_t - A_e \quad (1)$$

where

- A_e : external air temperature at time step t
- A_s : external air temperature at which heating is switched on
- A_t : internal air temperature the spaces need to be heated up to

⁹ Relative, that their actual value does not carry any meaning, only their value *relative* to each other.

For time steps (hours), where $A_e \geq A_s$,

$$RH_t = 0 \quad (2)$$

since at external air temperatures (A_e) that are not lower than the switching on temperature (A_s), no heating is needed.

Adjustment of individual values

After obtaining each RH_t , the time interval between the adjustments of the heating system is needed. There are two major reasons why this needs to be done in a model:

1. The adjustment of the output of heating systems can be inefficient if it is done every time the external air temperature changes.
2. The thermal inertia of buildings is high, which means there is a time lag between the adjustment of the heating system, and the actual thermal effect.

The district heating system's output is adjusted at time intervals. Since at every adjustment, the operators will have an expectation of the probable direction of the next interval's temperature change, the adjusted relative amount of heating needed is going to be determined by the average of the RH_t values that occur until the start of the next adjustment period.

Let P denote the number of adjustment periods within the time horizon.

$$P = \frac{T}{r} \quad (3)$$

where

r Number of time steps within an adjustment period

For each of the P adjustment periods the value of the *adjusted relative amount of heating* needed can be determined the following way:

$$ARH_p = \sum_{t=1+(p-1) \cdot r}^{t=p \cdot r} RH_t \cdot \frac{1}{r} \quad (4)$$

where

RH_t relative heating needed at time step t

r Number of time steps within an adjustment period

Each of the P adjustment periods contain r amount of time steps with a RH_t value. Each of the T original RH_t 's will change to the ARH_t value respective to the adjustment period (p) they are in (calculated with the help of (4)).

It is important to note, that there is a different relative amount of heat loss at different ambient temperatures. The rate depends on the specific size of the district heating system at the specific site. The adjustment for this phenomenon can be performed at the calibration phase.

Optional step: Deleting data for non-heating periods

In case that in the area of modelling, the district heating system does not supply the area with space heating during warmer periods of time, a non-heating period needs to be built in. During the non-heating period, even if the external air temperature (A_e) decreases below the switching on temperature (A_s), the plants serving district heating will only produce output for the production of sanitary hot water. When adjusting our data for non-heating period(s), the adjusted relative heating values need to be put into two categories:

For time steps, where time step t falls into a heating period:

ARH_t unchanged

For time steps, where time step t falls outside of heating period(s):

ARH_t replaced by value 0

The next step in the calculation method is adding the sanitary hot water usage. The usage of sanitary hot water is much less fluctuating than space heating, and is relatively unchanged throughout the year regardless of the external air temperature. In the model, the percentage of total heat output used for sanitary hot water is denoted by s . It will be assumed that its usage is constant throughout the year, since from a modelling perspective, the minor changes in the volume are not a factor to be considered.

The relative amount of the sanitary hot water needs to be added for each of the calculated values (ARH_t 's), regardless of whether they fall into the heating or non-heating category, since sanitary hot water is used throughout the year. The aggregated relative amount of sanitary hot water will be denoted by $AgRW$. The calculation of $AgRW$ is the following:

$$AgRW = \sum_{t=1}^T ARH_t \cdot \frac{1}{1/s-1} \quad (5)$$

where

- T Number of time steps within the examined time horizon
- s percentage of heat output used for sanitary hot water within the aggregated output of the heating system within the time horizon
- ARH_t adjusted relative amount of heating at time step t

The *relative value of sanitary hot water* for each time step is calculated the following way:

$$RW_t = \frac{AgRW}{T} \quad (6)$$

where

- $AgRW$ aggregated relative amount of sanitary hot water
- T Number of time steps within the examined time horizon

Please note that RW_t will obtain the same value for each of the t time steps. As a result, for each of the time steps, the adjusted relative heating values *with* sanitary hot water can be calculated the following way:

$$ARHW_t = ARH_t + RW_t \quad (7)$$

where

- ARH_t adjusted relative amount of heating at time step t
- RW_t relative value of sanitary hot water at time step t

These values are all relative, meaning that their value relative to each other is correct. In order to ease future calculations with these values, normalization is needed. The normalized adjusted heating needed with sanitary hot water for time step t , is calculated the following way:

$$NAHW_t = \frac{ARHW_t}{\sum_{t=1}^T ARHW_t} \quad (8)$$

where

$ARHW_t$ adjusted relative heating values *with* sanitary hot water t time step t

Having the $NAHW_t$ for each of the t time step enables us to easily calculate the value of the heat load for each time step, once we obtain the aggregated value of heat production for our modelling time horizon.

Applying the developed methodology

In the case of Pécs, the values needed for the developed calculation method are the following:

t :	one hour
T :	8760 (one year, from 1 st of January to 31 st of December) ¹⁰
A_l :	21 ° C
A_s :	15 ° C
r :	6 (six hours)
s :	0,2

The following section will go through the calculations for Pécs 2012. If possible, each calculation will be conducted for a specific time step (2012.11.11. 11:00), and the graphs for the whole year will be developed.

RH_t : relative heating needed at time step t ($t = 7,548$) Using (2),

Input data:

A_e :	11.6 ° C
A_s :	15 ° C
A_l :	21 ° C

¹⁰ Please note, that although the air temperature and electricity load data is from 2012, the leap day (29th of February) is excluded from the data set and further calculations. This makes models from different years more easily comparable.

since $A_e < A_s$, the calculation of RH_{7548} :

$$RH_{7548} = A_l - A_e = 21 - 11.6 = 10.4$$

Graph of all $T = 8760$ RH_t values:

Figure 7: Relative heating needed

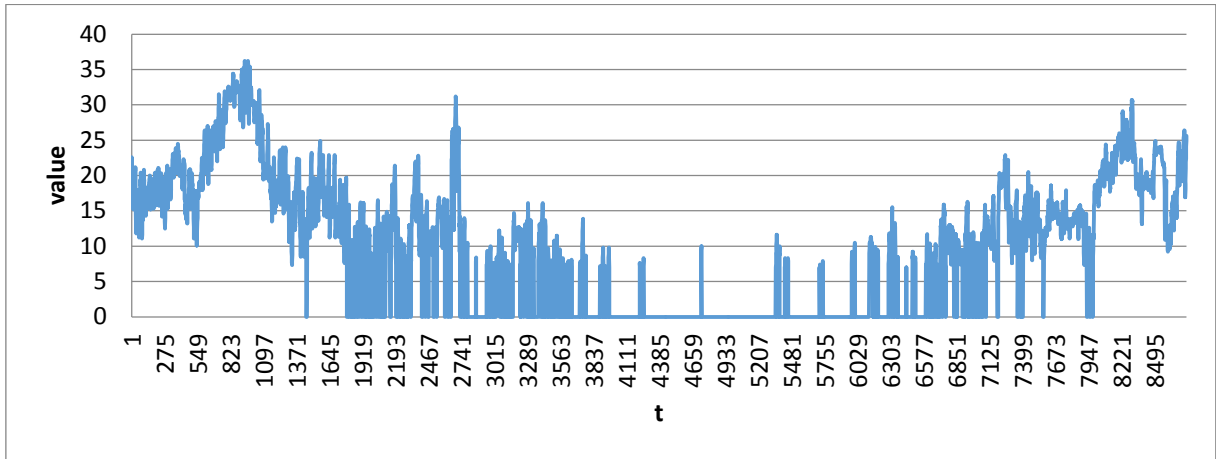

Source: Own edition

Determining P , the number of adjustment periods within the time horizon, using (3)

Input data:

$$T: \quad 8760$$

$$r: \quad 6$$

$$P = \frac{T}{r} = \frac{8760}{6} = 1460$$

ARH_p : adjusted relative amount of heating for adjustment period p ($p = 1,258^{11}$). Using (4),

Input data:

$$r: \quad 6$$

$$ARH_{1258} = \sum_{t=1+(p-1) \cdot r}^{t=p \cdot r} RH_t \cdot \frac{1}{r} = \sum_{t=1+(1258-1) \cdot 6}^{t=1258 \cdot 6} RH_t \cdot \frac{1}{6} = 11.6$$

¹¹ The value was chosen so that $t=7548$ would fall into the calculated adjustment period

Intermediate values:

RH_{7543} :	10.4
RH_{7544} :	11.1
RH_{7545} :	11.6
RH_{7546} :	13.2
RH_{7547} :	13.1
RH_{7548} :	13.2

Graph of all $T = 8760 ARH_t$ values:

Figure 8: Adjusted relative amount of heating needed

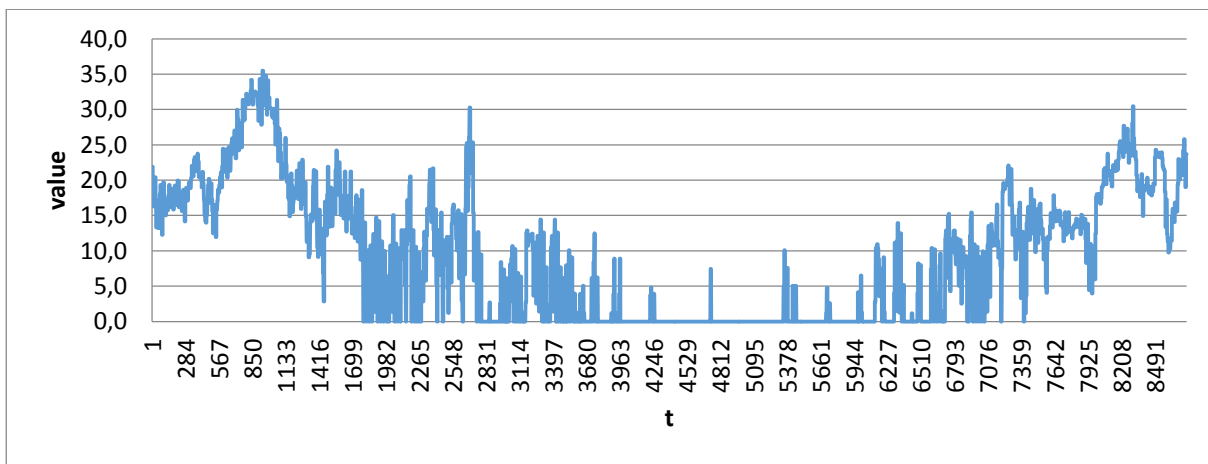

Source: Own edition

Since for the modelled area (Pécs, Hungary), there is a heating and a non-heating season, the adjusted relative amount of heating needed has to be corrected. The non-heating season for the modelled year (2012) is from 1st of May to the 9th of October, or from $t = 2,881$ to $t = 6,744$. ARH_t values inside this period will be substituted to value 0. Graph of all $T = 8,760 ARH_t$ values:

Figure 9: Adjusted relative amount of heating needed - with non-heating period

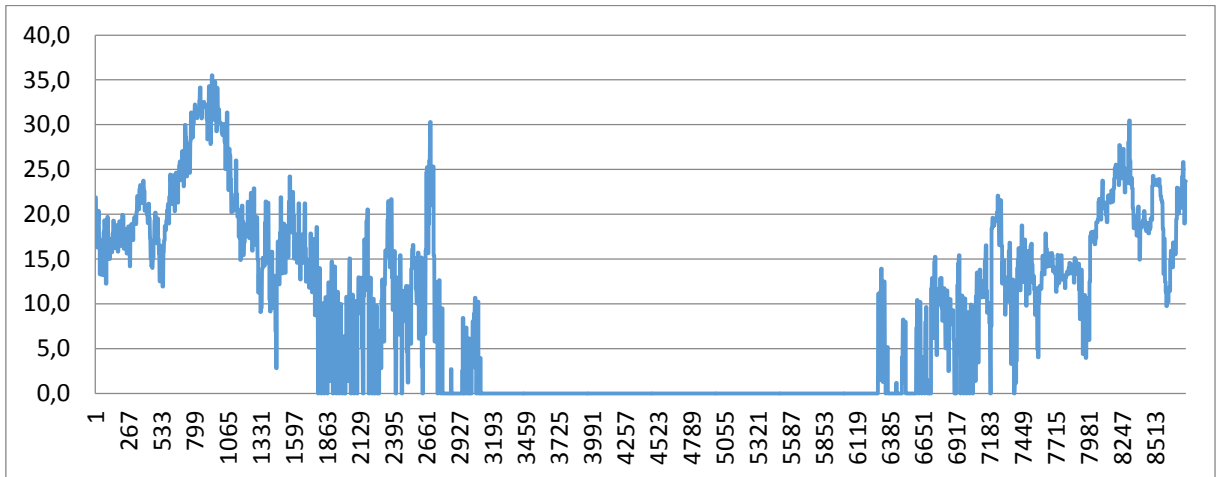

Source: Own edition

The next step is adding the relative amount of hot water to the values. For this, the aggregated relative amount of sanitary hot water is needed. For this, (5) will be used.

Input data:

$$s: \quad 0.2$$

$$AgRW = \sum_{t=1}^T ARH_t \cdot \frac{1}{1/s - 1} = 81,876 \cdot \frac{1}{1/0.2 - 1} = 20,469$$

The aggregated relative amount of sanitary hot water needs to be distributed among the $T = 8760$ time steps. The relative value of sanitary hot water can be calculated with the help of (6)

Input data:

$$T: \quad 8,760$$

$$AgRW: \quad 20,469$$

$$RW_t = \frac{AgRW}{T} = \frac{20,469}{8,760} = 2.34$$

Please note that the use of sanitary hot water is assumed to be constant throughout the year. After obtaining ARH_t and RW_t values, the adjusted relative heating values *with* sanitary hot water can be calculated for time step t ($t = 7,548$) Using (7),

Input data:

$$ARH_{7548}: 11.6$$

$$RW_{7548}: 2.34$$

$$ARHW_{7548} = ARH_t + RW_t = 11.6 + 2.34 = 13.94$$

Graph of all $T = 8760$ $ARHW_t$ values:

Figure 10: Adjusted relative amount of heating needed - with non-heating period - with sanitary hot water

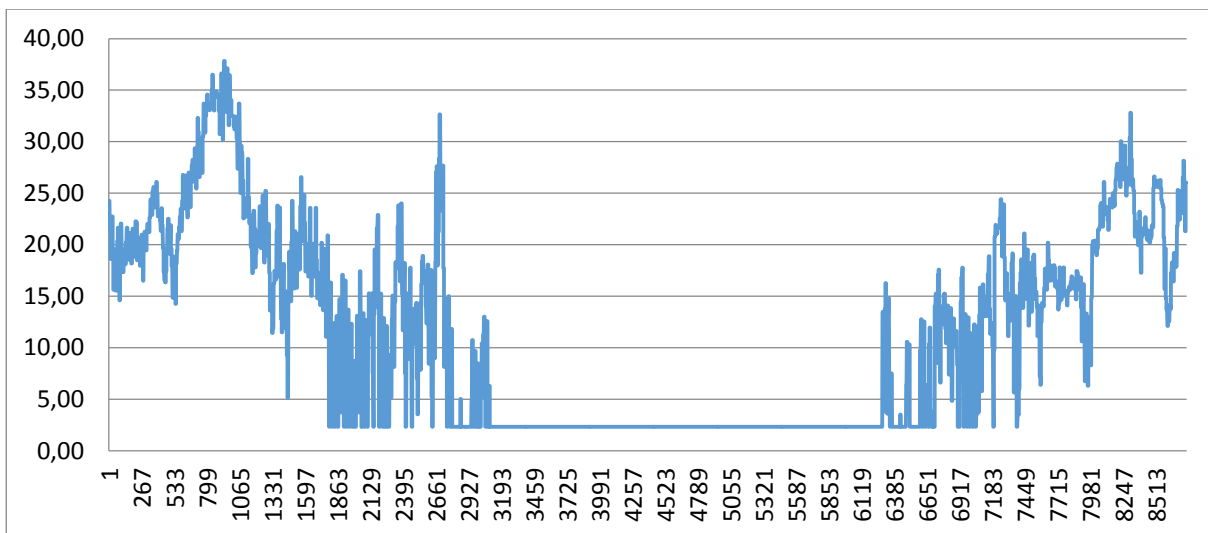

Source: Own edition

The last step is to develop a normalized version of the duration curve, so it can be used to model different sized systems. Each $ARHW_t$ value will change to a normalized value between 0 and 1, with the help of (8):

Input data:

$$ARH_{W7548}: 13.94$$

$$NAHW_{7548} = \frac{ARHW_t}{\sum_{t=1}^T ARHW_t} = \frac{13.94}{96,313.22} = 0.000145$$

Graph of all $T = 8760$ $NAHW_t$ values:

Figure 11: Normalized adjusted heating needed with sanitary hot water

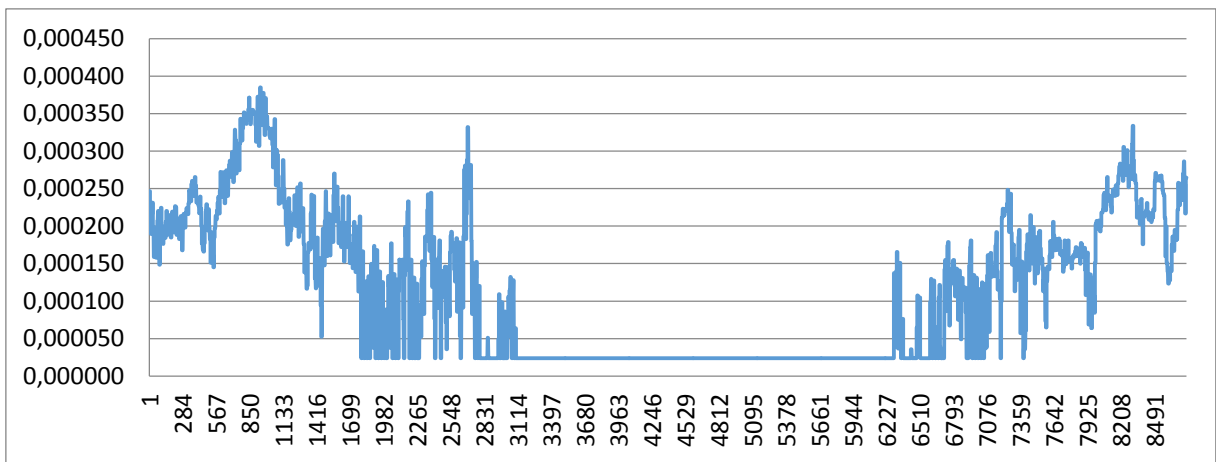

Source: Own edition

Sorting the $NAHW_t$ value from largest to smallest yields us the normalized duration curve of the modelled heating system:

Figure 12: Normalized adjusted heating needed with sanitary hot water, duration curve

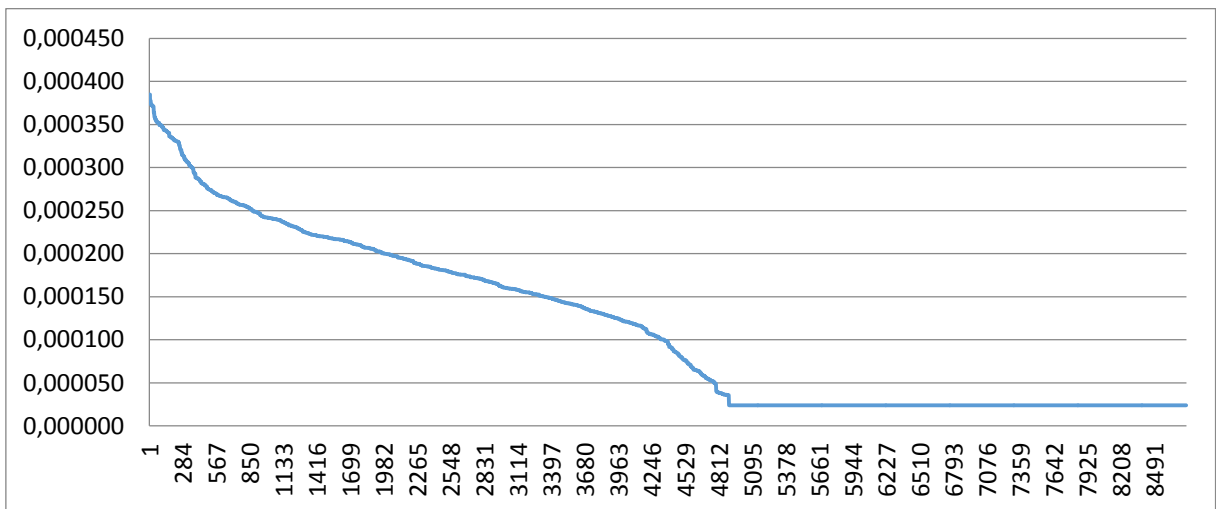

Source: Own edition

Demand for Natural Gas

The aggregated data for natural gas demand for from Table 12. 1,844 *TJ* is equal to 512,222.22 *MWh*. This value has to be divided into the natural gas consumption of the power plant (used for district heating and electricity production) and the consumption of other users. For this group, the actual heat demand differs from this value, since there are losses in the conversion process. The natural gas is used by boilers with the efficiency of 80-95%¹², with the newest technologies reaching 103% in certain cases. Since the newest technologies are not widely spread, 85% efficiency will be used.

$$512,222.22 \cdot 0.85 = 409,777.8 \text{ MWh}$$

This will be distributed among the 8760 hours of a year with the help of $NAHW_t$ values, which yields the following duration curve. The $NAHW_t$ values can be used, natural gas is almost exclusively used for space heating, cooking, and heating of water.

Figure 13: Heat demand. Natural gas

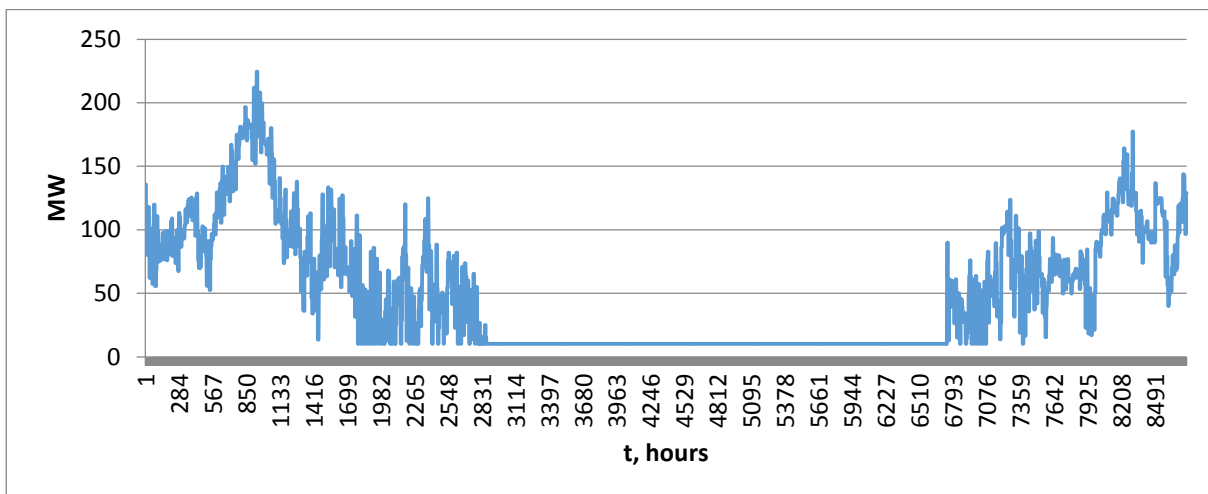

Source: Own edition

Demand for District Heat

The aggregated data for the district heat demand is from Table 12. 1,266 *TJ* is equal to 351,666 *MWh*. In the city of Pécs, the heat is bought from the power plant that produces electricity and sells the excess heat. An intermediary company (PÉTÁV Ltd) is responsible for the distribution of the heat in the district heating system. According to the company the

¹² Energy Strategy (2013)

heat supplied by the power plant in 2012 was 1,488 *TJ*. This value needs to be used for the distribution values, since this is the amount the city needs in order to supply the 1,266 *TJ*.

The amount (1,488 *TJ* equal to 413,273 *MWh*) will be distributed among the 8760 hours of a year with the help of $NAHW_t$ values, which yields the following duration curve. The $NAHW_t$ values can be used, district heating exclusively serves space heating, cooking, and heating of water.

Figure 14: Heat demand, District Heating

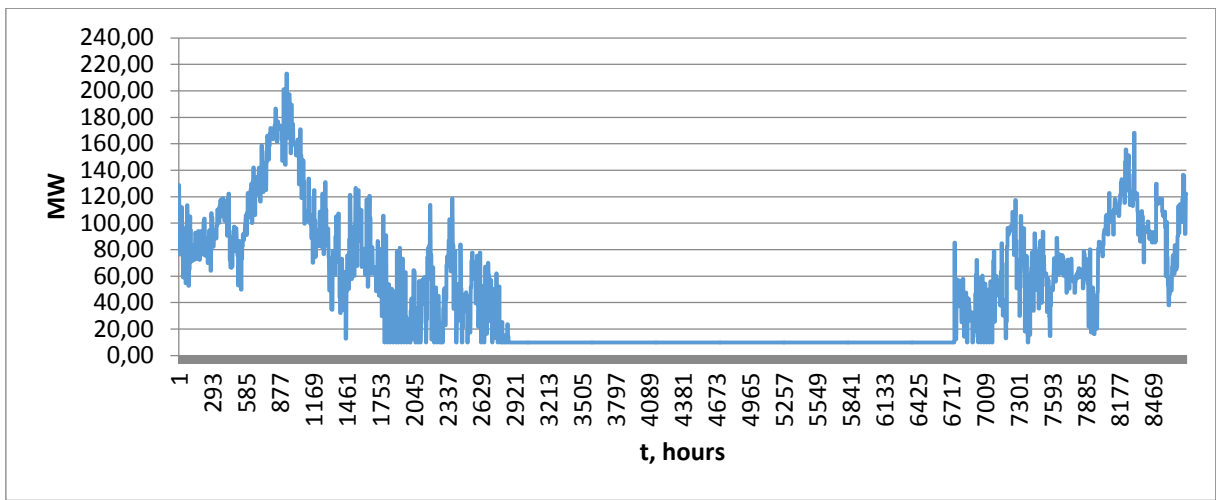

Source: Own edition

Demand for Firewood

The aggregated data for the district heat demand is from Table 12. The 556 *TJ* is equal to 154,444 *MWh*. The actual heat demand differs from this value, since there are losses in the conversion process. The firewood is used by boilers with the efficiency of 60-80%¹³. As a conservative measure, 65% efficiency will be used.

$$154,444 \text{ MWh} \cdot 0.65 = 100,389 \text{ MWh}$$

This will be distributed among the 8760 hours of a year with the help of $NAHW_t$ values, which yields the following duration curve.

¹³ Energy Strategy (2013)

Figure 15: Heat demand Individual heating, wood

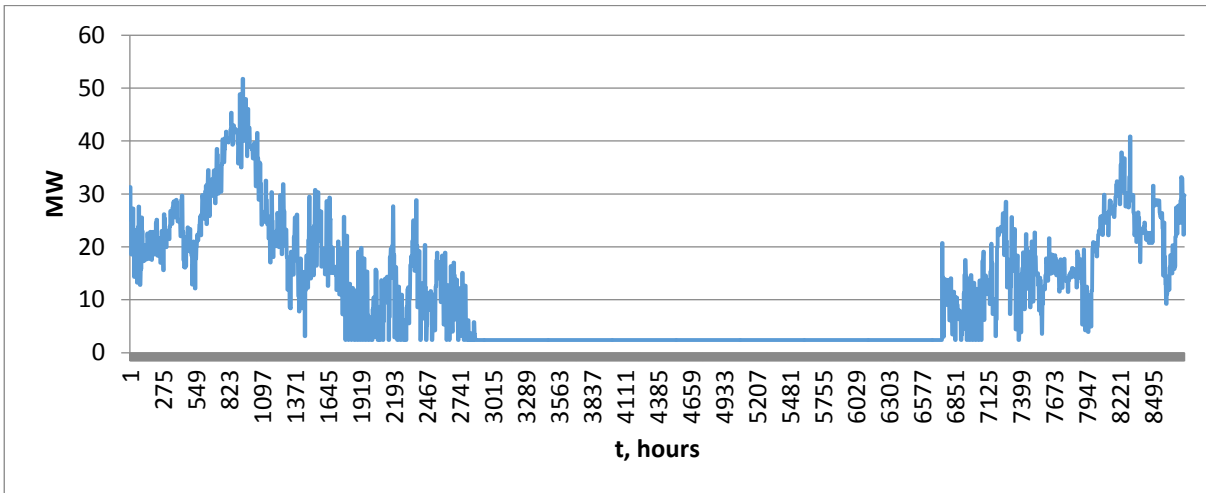

Source: Own edition

Electricity

One of the three major parts of modelling energy systems is the supply and demand for electricity. In the case of the city of Pécs, determining the hourly values of electricity demand is not a straight forward matter. According to the energy strategy of Pécs, the aggregated volume of electricity supplied was 1620 Tj in 2012.

Since only the aggregated value is known, a methodology for determining the distribution of the 1620 Tj between the 8760 hours of a year is necessary. There is no publicly available source for this data.

Determining the distribution of electricity demand

The pattern of electricity demand is not known for Pécs as a city. The closest area in size for which there is publicly available data with similar demand pattern to Pécs is the country of Hungary. The load values for the Hungarian electricity system can be accessed at the homepage of the Hungarian Independent Transmission Operator Company Ltd. (MAVIR). The time step can be reduced down to fifteen minute intervals, but for the current model's purpose a dataset containing the load values for each of the 8760 hours within a year will be satisfactory. The demand pattern for the Hungarian electricity system is the following for year 2012:

Figure 16: Electricity demand pattern, Hungary 2012

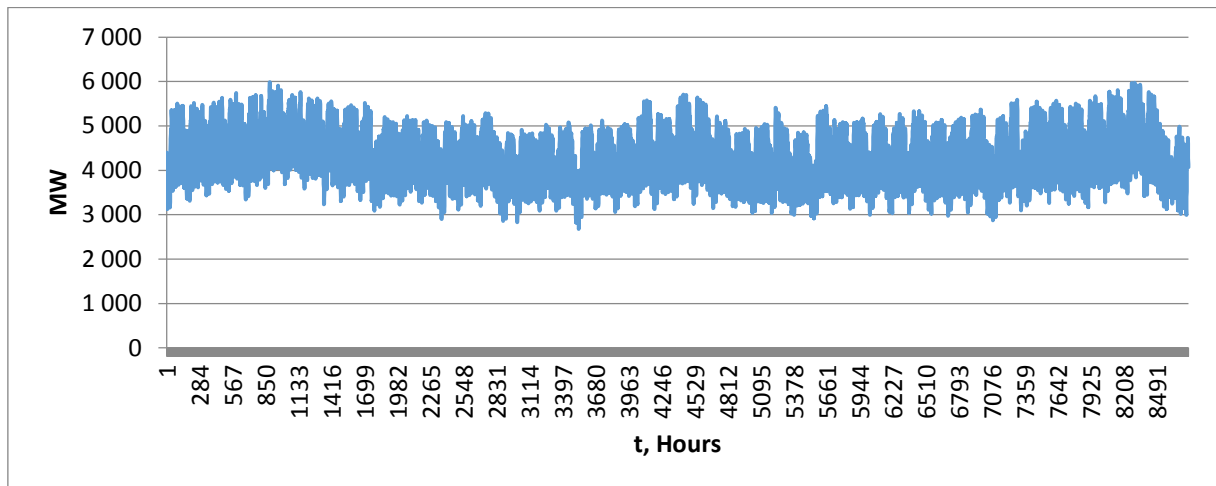

Source: Own edition, based on the data from MAVIR

The minimum and maximum loads are 2,681 MW and 5,987 MW respectively.

Simply scaling down this demand pattern for Pécs is not possible until further examination of the differences between the type and proportion of consumers between the city of Pécs and Hungary.

The following section will develop the methodology for dealing with proportional and demand pattern differences when scaling from a different sized duration curve.

General methodology

The scaling of electricity demand patterns acquired from a different sized area is an important step when no official data is available.

When a data set is acquired where the volume of the demand is different from volume of the researched area - due to a different number of consumers connected to the system - corrections need to be made. This model only deals with cases where the time step of the acquired data set is the same as the time step and the time horizon for the researched area. The method will assume that the aggregated electricity demand for the researched time horizon and for specific demand factors are available for both areas.

The demand for electricity is made up from different groups of consumers, referred to as factors from now on. If there is data that suggests that any of the factors' proportion

compared to the total demand or their demand pattern is significantly different in the area we acquired data for than the research area, corrections will have to be made accordingly.

Let M denote the area data was acquired for, and N the area of research. EM_t will denote the value¹⁴ of electricity demand for area M at time step t .

If there is no data that suggests that the proportion of different factors or their demand pattern is significantly different, a simple scaling method can be used to determine the values for the researched area, denoted by EN_t :

$$EN_t = EM_t \cdot \frac{AgEN}{AgEM} \quad (9)$$

where

EM_t	Value of electricity demand for area M at time step t
$AgEN$	Aggregated electricity demand for area N for the researched time horizon
$AgEM$	Aggregated electricity demand for area M for the researched time horizon

If this is not the case, the following steps need to be made:

After identifying factors whose proportion or demand pattern is different in area M than in area N , each EM_t will have to be scaled and corrected in correspondence to all such factors. The following section will develop a methodology for correcting a proportional issue. Let f denote the factor(s), and F the number of factors whose proportion is different in the two areas.

As a first step, all the data in the data set for area M needs to be stripped from the values that can be attributed to factor f . These data will be denoted by $CfEM_t$ (factor corrected electricity demand for area M at time step t)

$$CfEM_t = EM_t - EMf_t \quad (10)$$

where

EM_t	Value of electricity demand for area M at time step t
EMf_t	Value of electricity demand of factor f for area M at time step t

¹⁴ Usually expressed in Wh, kWh, mWh, gWh, tWh or pWh

Since there is no general formula to determine the electricity demand of factor f at time step t (EMf_t , or ENf_t) for any kind of factor, a general model will be shown, where the electricity demand of factor f will be assumed to be constant. Please note, that for the actual electricity load of a given factor, specific datasets, or assumptions are needed.

Determining the electricity demand of factor f at time step t (EMf_t) when the electricity demand of factor f is constant throughout the research period:

$$EMf_t = \frac{AgEMf}{T} \quad (11)$$

where

$AgEMf$ Aggregated electricity demand of factor f in area M during the researched time horizon

T Number of time steps within the examined time horizon

With the help of EMf_t , the $CfEM_t$ can be calculated. This step needs to be done F number of times (each time for a different f), and each time using the obtained $CfEM_t$ data as a new base for correction. The data that is stripped of all F factors is denoted by CEM_t , corrected electricity demand for area M at time step t . After obtaining this data for all t 's, the scaling can be done without the danger of distorting our data set:

$$CEN_t = \frac{CEM_t}{\sum_{t=1}^T CEM_t} \cdot (AgEN - \sum_{f=1}^F AgENf) \quad (12)$$

where

CEM_t Corrected electricity demand for area M at time step t

$AgEN$ Aggregated electricity demand for area N for the researched time horizon

$AgENf$ Aggregated electricity demand of factor f for area N for the researched time horizon

The result is the factor corrected value of electricity demand of area N for time step t (CEN_t). The last step is to add the sum of electricity demand of all F factors for each time step t , which can be obtained for each f with the help of the same principles used in (10):

$$ENf_t = \frac{AgENf}{T} \quad (13)$$

where

$AgENf$ Aggregated electricity demand of factor f in area N during the researched time horizon

T Number of time steps within the examined time horizon

$$EN_t = CEN_t + \sum_{f=1}^F AgENf_t \quad (14)$$

where

CEN_t Factor corrected value of electricity demand of area N for time step t

$AgENf_t$ Electricity demand of factor f for area N for time step t

Application of the developed calculation method

For modelling the electricity demand for the city of Pécs, the data of the Hungarian electric system (described earlier) will be used. Notations, and predetermined values are the following:

$area N$	City of Pécs
$area M$	Hungary
$AgEN$	450 GWh ¹⁵
$AgEM$	38 909 GWh ¹⁶
$AgENf$	73.6 GWh ¹⁷
$AgEMf$	11 128 GWh ¹⁸
EN_t	Data set acquired from Hungarian TSO
t :	one hour
T :	8760 (one year, from 1 st of January to 31 st of December) ¹⁹

¹⁵ Energy Strategy (2013)

¹⁶ Hungarian TSO - MAVIR – Official data

¹⁷ Energy Strategy (2013)

¹⁸ Hungarian Energy Balance – International Energy Agency www.iea.org

¹⁹ Please note, that although the air temperature and electricity load data is from 2012, the leap day (29th of February) is excluded from the data set and further calculations. This makes models from different years more easily comparable.

Examination of different factors needs to be done in order to determine if the simple scaling method can be used.

According to the local electricity supplier (E.ON, www.eon.hu), the demand for electricity can be categorized into the following groups²⁰:

- Residential
- Industry
- Communal
- Agriculture
- Street-lighting
- Other

According the energy strategy of Pécs, in the city the aggregated demand is distributed among the different groups the following way:

Figure 17: Distribution of electricity demand by sector, Pécs

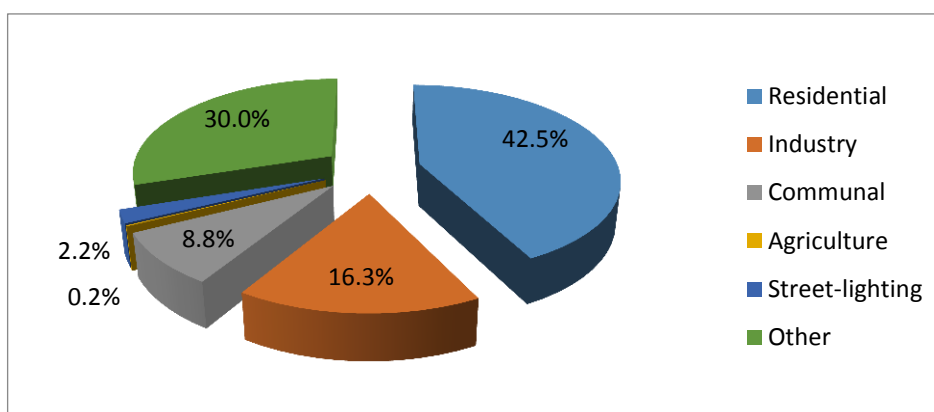

Source: Own edition based on Energy Strategy, 2013

When determining the demand pattern of electricity for the city of Pécs, with the help of Hungary's demand pattern, a close examination of the different groups need to be done. If there is a major electricity using group, whose weight is different in the city of Pécs, than in Hungary, than that groups' electricity usage needs to be adjusted for. In the process of examination the Energy Balance of Hungary (published by the International Energy Agency (www.iea.gov)) will be used. It is important to note that the groups listed in this work represent the groups determined by the electricity supplier of Pécs (E.ON, www.eon.hu). The groups created by the International Energy Agency can be different in terms of grouping

²⁰ Energy Strategy of Pécs (2013)

consumers. The two exceptions are the groups of *Industry* and *Agriculture*, where the identification of consumers is simpler.

- Residential: There is no reason to believe that the proportion of residential usage in the city of Pécs is significantly different from Hungary as a whole.
- Industry: The size of the industry in Pécs (regarding electricity consumption) is 16.3%²¹, and 28.6% in Hungary²²
- Communal: There is no reason to believe that the proportion of communal usage in the city of Pécs is significantly different from the proportion in Hungary as a whole.
- Agriculture: The size of the industry in Pécs (regarding electricity consumption) is 0.2%⁶, and 2.2% in Hungary⁷
- Street-lighting: There is no reason to believe that the proportion of street-lighting usage in the city of Pécs is significantly different from Hungary as a whole.
- Other: The definition of the group *Other* can vary greatly between the documentation of the Local supplier, and the International Energy Agency, the comparison is not made.

There were two cases, where there could be a need for correction: *Industry* and *Agriculture*.

Industry: There are two reasons why correction is needed for the usage of industry. Not only is the proportion of electricity usage is double regarding Hungary, but the industry's demand pattern in general differs from the main demand pattern identified earlier.

Agriculture: The difference between the portions of electricity usage within the agriculture sector is tenfold (0.2% to 2.2%). Since the relative volume of agriculture within the aggregated electricity usage is negligible, it is not essential to further investigate the demand pattern differences.

Because of the two identified cases (out of which industry needs to be corrected for), the simple scaling method (9) can not be used. The industry factor will be denoted by f .

The first step is to strip the data obtained for Hungary from the industry's electricity use. To use formula (10) the value of electricity demand of factor f for area M at time step t will be needed. Since there is no specific data for the industry's electricity demand patter

²¹ Energy Strategy of Pécs (2013)

²² Hungarian Energy Balance – International Energy Agency www.iea.org

within Hungary, an assumption of constant industry electricity use will be used. For the calculation, (11) will be used.

$$EMf_t = \frac{11\,128\text{ GWh}}{8760} = 1,27\text{ GWh}$$

After calculating EMf_t , CEM_t can be calculated with the developed methodology for each time step.

Figure 18: CEM_t

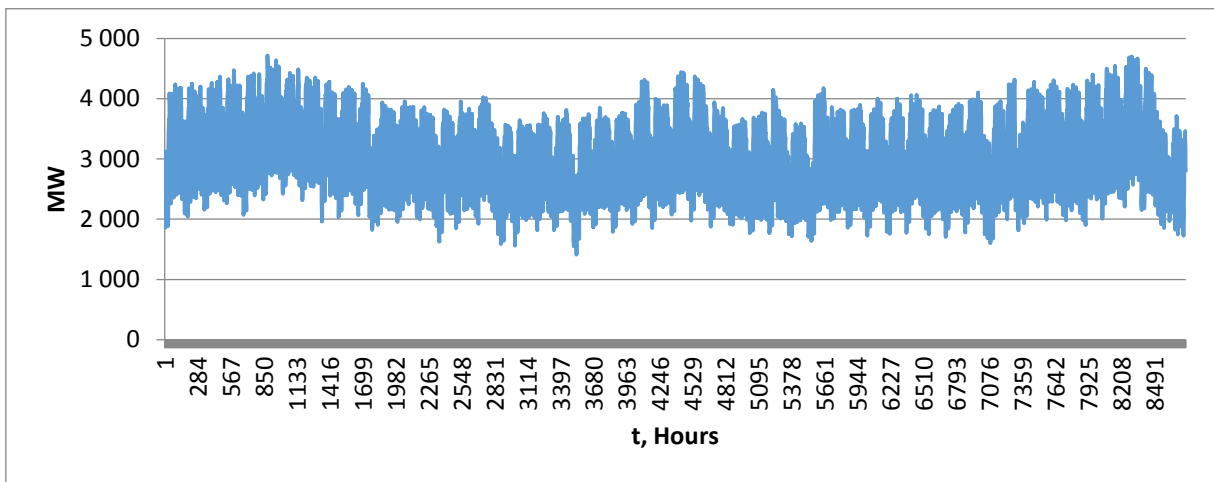

Source: Own edition

The next step is scaling the new dataset for the size of Pécs, with the help of (12):

Figure 19: CEN_t

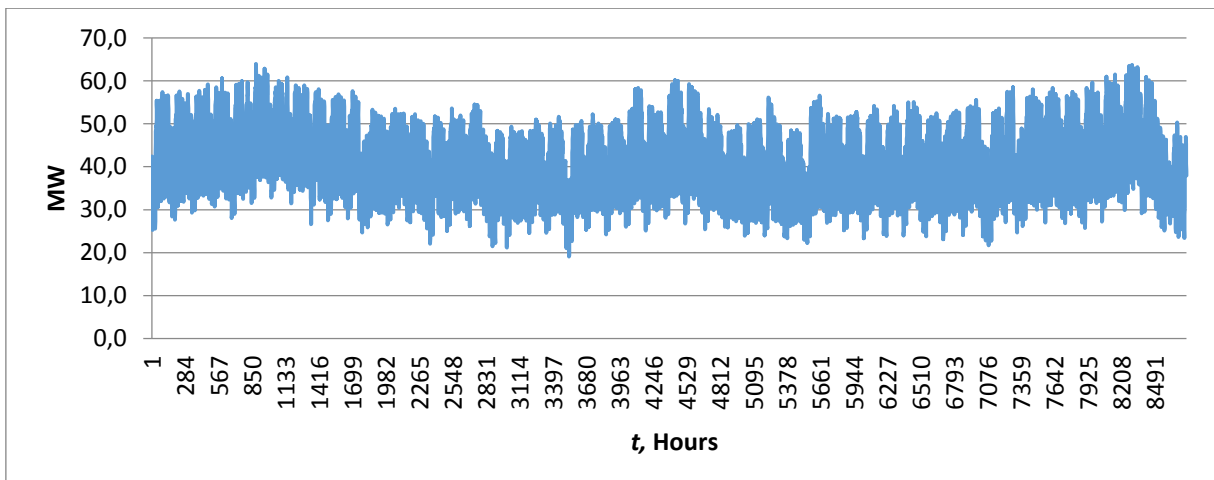

Source: Own edition

The last step is adding the industry's electricity demand for each of the data points (time steps). The calculation of the electricity demand of factor f for area N for time step t is the following (13):

$$ENf_t = \frac{73,6 \text{ GWh}}{8760} = 0,0084 \text{ GWh}$$

Adding the values to the industry factor corrected value of electricity demand of area Pécs for each time steps (using (14)), yields the following duration curve, which can be used to model the electricity demand of Pécs.

Figure 20: EN_t

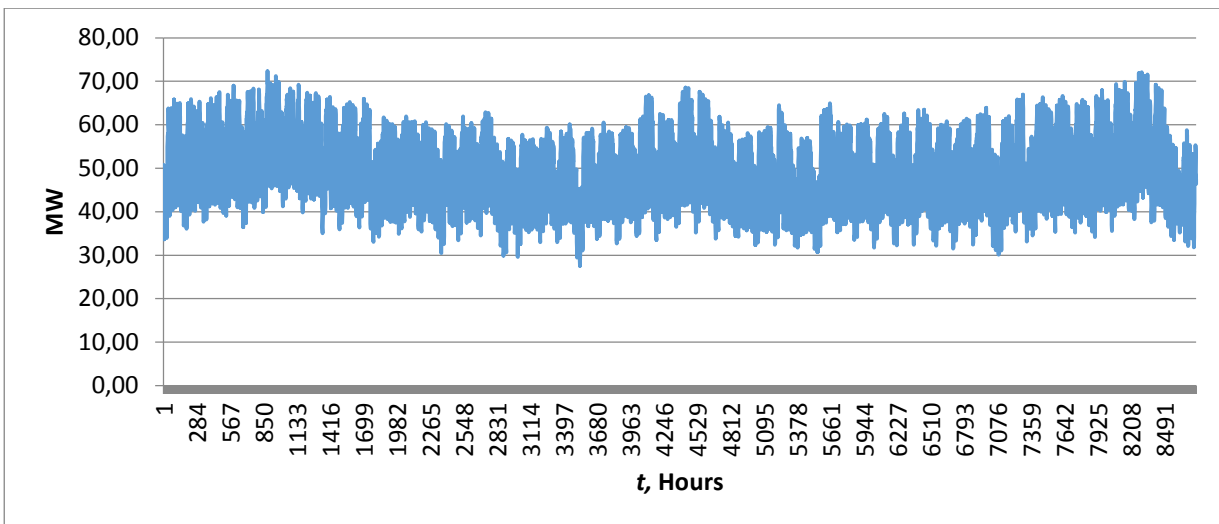

Source: Own edition

Transportation

Traditional vehicles

The demand for this category will be made up of purely the energy demand in the form of fuel. The following table lists the vehicles by category and their aggregated yearly petrol and diesel fuel demand. According to the source of the data, the values are already corrected for transit vehicles.

Table 13: Petrol and diesel fuel demand for vehicle categories

Vehicle Category	SUM (1 10³)	Petrol (1 10³)	Diesel (1 10³)
Automobile	23,510	13,345	10,165
Bus (local transportation)	3,986	0	3,986
Bus (point-to-point transportation)	1,082	0	1,082
Small and Medium Utility Trucks	3,380	180	3,200
Large Utility Trucks	1,895	20	1,875
SUM:	33,853	13,545	20,308

Source: Own edition based on Energy Strategy (2013)

The energy demand in this case is expressed in liter of fuel. Since for purpose of modelling a standardized measurement is needed, the fuel demand needs to be converted into *KWh*, as used by the other two main parts of the model (heat and electricity). For this calculation, the energy content of one liter of fuel is needed.

Table 14: Energy content of Diesel and Petrol fuels

	KWh/m³	KWh/liter
Diesel	9,945	9.94
Petrol	8,988	8.99

Source: CTA, 2013

Table 15: Energy Demand for Vehicle Categories (MWh)

	E-demand Petrol	E-Demand Diesel
Automobile	119,943	101,088
Bus (local transportation)	0	39,640
Bus (point-to-point transportation)	0	10,760
Small and Medium Utility Trucks	1,618	31,823
Large Utility Trucks	180	18,646
SUM:	121,740	201,958

Source: Own calculation based on the previous two tables

The aggregated fuel demand is now known for the city of Pécs. Since the distribution of the demand is irrelevant from the perspective of our current modelling method, a uniform distribution will be used among the 8760 hours.

Supply side

In order to serve the demand developed in the previous chapter, the supply side of the model needs to be developed. The supply side will consist of the energy systems that convert primary energy into secondary energy to supply the energy consumers.

Table 16: Supply side actors

Primary Energy Sources	Energy Conversion Units	Secondary Energy	Energy Consumers
Natural Gas	Fossil Fuel Power Plants	Electricity	Residential Sector
Crude Oil	CHP Power Plants	Enthalpy	Communal Sector
Coal	Biomass fired Boilers	Fuel	Industry
Biomass	Natural Gas fires Boilers		Transportation

Source: Own edition

Currently, the major secondary energy demand of Pécs consists of electricity, enthalpy and fuel which supply the electricity, heat and transportation demand respectively. The following section will introduce the converting energy systems of the city with respect to their function and properties that are important from a modelling perspective.

External data

The external data needed for the modelling process for different category groups:

Table 17: External data needed

Category	External data needed
Heat demand	Ambient temperature
Photovoltaic	Ambient temperature
	Solar radiation
Solar collectors	Ambient temperature
	Solar radiation

Source: Own edition

Ambient temperature

The ambient temperature for each time step of the modelling process can be obtained three ways:

1. The EnergyPRO modelling framework offers access to Climate Forecast System Reanalysis database, which contains the hourly air temperatures for the area.

2. The University of Pécs has a detailed database with the air temperatures for the city of Pécs
3. The district heating supplier of Pécs (PÉTÁV) has the air temperatures from their own system.

Although all three choices would be sufficient, because the data provided by the district heating supplier will be used for determining the distribution of heat, it will be used for all modules that need the ambient temperatures within the model. The ambient air temperature for the year 2012 is the following:

Figure 21: Ambient air temperature, Pécs, 2012

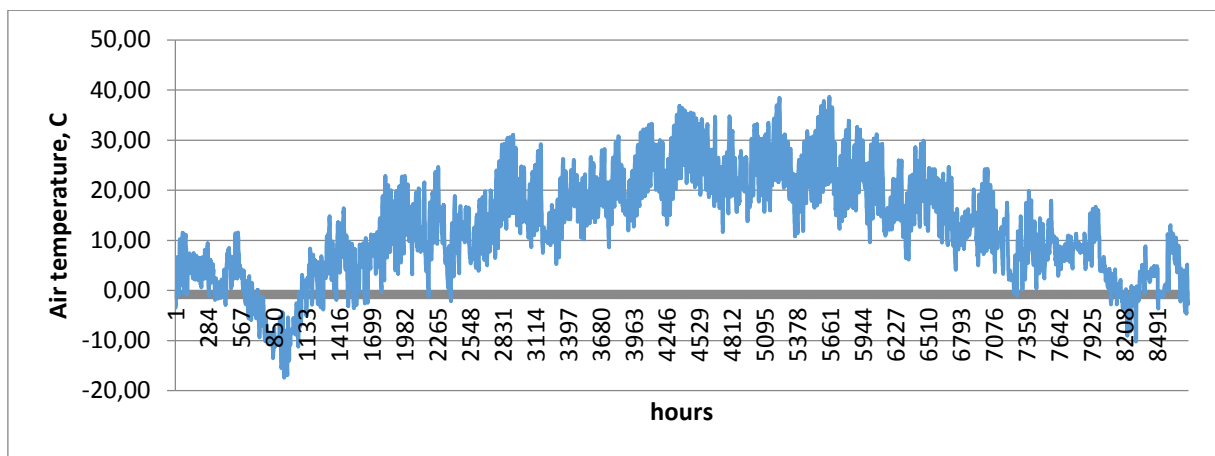

Source: Own edition

Solar radiation

The solar radiation values were obtained with the help of the EnergyPRO modelling framework, which offers access to Climate Forecast System Reanalysis database. The hourly values for solar radiation (in W/m^2) for 2012 are the following:

Figure 22: Solar radiation, Pécs, august 3rd-9th , 2012

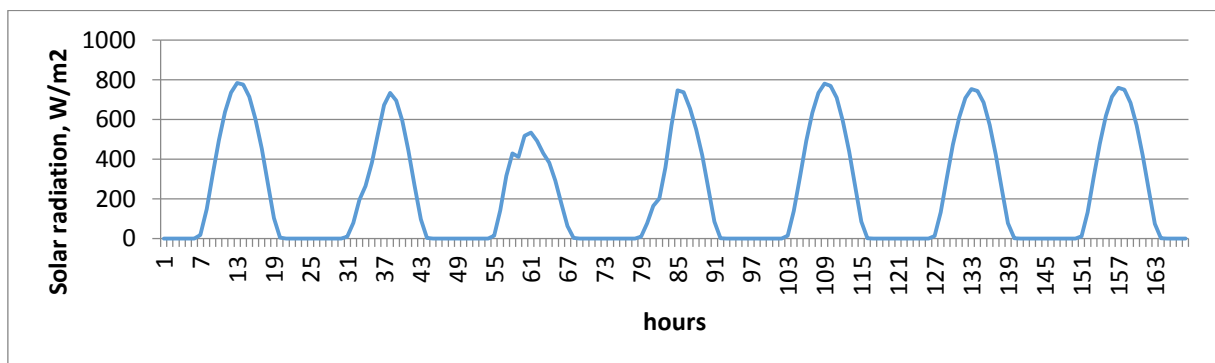

Source: Own edition

Figure 23: Solar radiation, Pécs, 2012

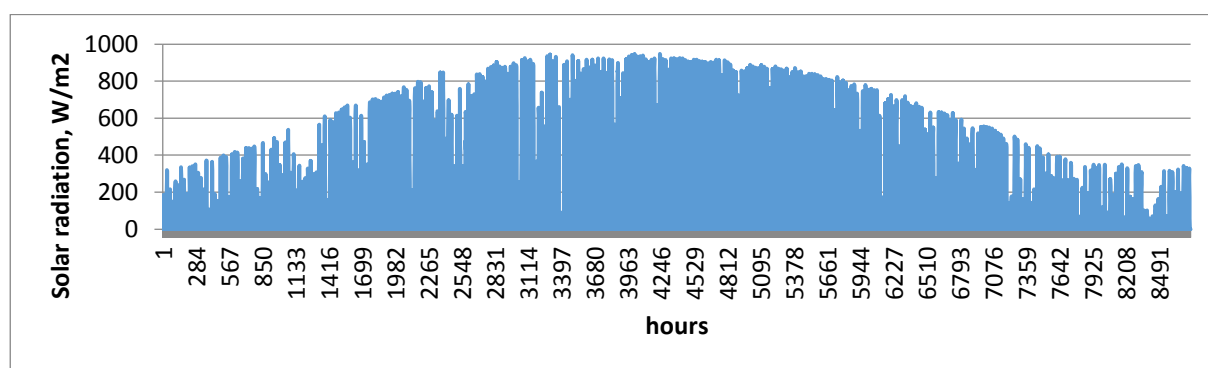

Source: Own edition

According to energyPRO: Solar radiation time series created from online CFSR2 data at position 46.10N 18.21E in the year 2012. This is on the outskirts of Pécs.

Energy Sources

The major energy sources used by the current and future (modelled) energy system of Pécs are listed in the following table:

Table 18: Energy content of energy sources

Fuel²³	E-content	
Natural Gas	9.44	KWh/m3
Biomass (wood)	3,278	KWh/ton
Biomass (straw)	4,032	KWh/ton
Agricultural & Municipal waste	5,000	KWh/ton
<i>Biogas</i>	6.00	KWh/m3
<i>Oil</i>	10,039	KWh/m3
<i>Coal</i>	5,728	KWh/ton
<i>Hungarian grid fuel</i>	1,000	KWh/unit
Petrol	8,988	KWh/m3
Diesel	9,945	KWh/m3

Source: Own edition

The energy content of each fuel is essential for future calculations. The following principle is used: If there is data available for the expected energy content of the different fuels for the specific processes, they will be used. If no data is available, the determination of the energy content will be based on publicly available data on the specific fuel.

²³ Energy source with italics are for the modelling of future energy systems

Natural Gas: The heating value was based on the *Lower and Higher Heating Values of Gas, Liquid and Solid Fuels* published by the Center for Transportation Analysis: 10.17 KWh/m³.

Biomass (woodchip): Since the energy content of different kinds of wood and woodchip can be different - if possible - it is important to obtain the actual energy content that is fed into the modelled energy system. In the current case woodchip will be used by a power plant in southern Pécs (discussed in detail later). On page 9 of the document (Pannongreen, 2009), the company Pannongreen - who operates the woodchip unit of the power plant – states that the expected water content of the woodchip they use is between 25 – 45%, with the energy content of 9,000 to 12,500 KJ/Kg. The average water content is documented to be 29%. Energy content is inversely proportional to water content. A linear approximation yields us a result of 11,800 KJ/Kg. This equals to 3,278 KWh/ton.

Biomass (straw): The expected energy content of the straw they use is not publicly available at the moment. The energy content is based on the publication of Teagasc, the Agriculture and Food Development Authority of Ireland. The energy content of wheat straw, with 15% moisture is: 4,032 KWh/ton

Agricultural & Municipal waste: The energy content of this category can vary widely. The heating value was based on the *CTA (2013)* published by the Center for Transportation Analysis lists several types of agricultural waste ranging from 3,000 KWh to more than 5,000 KWh/ton. The energy content of manure is also listed between 12 and 20 GJ/ton depending on a lot of factors. The value used for modelling is decided to be: 5,000 KWh/ton.

Biogas: (Pettersson and Wellinger, 2009) determine the lower heating value of biogas to be 6.5 KWh/m³. (Hajdú, 2009) states that the energy content of biogas is 21.6 MJ/m³ (6 KWh/m³). Since the latter paper was used by the authors of the energy strategy of Pécs, 6 KWh/m³ will be used.

Oil: The heating value was based on the *CTA (2013)* published by the Center for Transportation Analysis: 10,039 KWh/m³.

Coal: The heating value was based on the *CTA (2013)* published by the Center for Transportation Analysis: 5,728 KWh/ton.

Hungarian grid fuel: The Hungarian grid fuel is an artificial fuel used in cases when the modelled city's electricity producing units will not be able to meet the demand. In this case an artificial power plant, the *Hungarian_Grid* plant will produce electricity for the city. This artificial plant will represent the whole Hungarian electricity producing system, excluding the capacities of the modelled city Pécs. Since it would not be feasible to model all the electricity producing units of Hungary, and the surrounding countries' for this one purpose, a simplified approach will be used.

A document published by the Hungarian Independent Transmission Operator Company Ltd. (MAVIR) in 2013 lists all the production units that fed electricity into the Hungarian grid in 2012.

Table 19: Production characteristics of Hungarian electricity production units, 2012

2012	Electricity, GWh		Heat	Used Input energy, GWh					Eff.
	produced	output	output	coal	oil	n. gas	nuclear	other	
Sum of all plants in Hungary	34,394	32,047	10,148	19,419	544	26,842	47,844	7,210	0.414
Total Input energy (GWh)	101,859	% of total:		0.19	0.01	0.26	0.47	0.07	

Source: Own edition based on: Supply side analysis, 2013

The several types of energy sources need to be mixed into an artificial fuel that will feed the *Hungarian_Grid* plant. A satisfactory solution for this problem is to assign a standard measurement (*unit*) to this new fuel with the energy content of 1,000 *KWH/unit*. Every *unit* that the model uses from this fuel source can be broken back down into the separate energy sources, and assessed.

The new fuel's properties are the following:

HUN_Grid_Fuel:	1,000	KWh/unit
-----------------------	--------------	-----------------

Petrol: The heating value was based on the *Lower and Higher Heating Values of Gas, Liquid and Solid Fuels* published by the Center for Transportation Analysis: 8,988 *KWh/m3*.

Diesel: The heating value was based on the *Lower and Higher Heating Values of Gas, Liquid and Solid Fuels* published by the Center for Transportation Analysis: 9,945 *KWh/m3*.

Other (local) and Other (outside): There will be two groups of fuel that are not specified in detail. The other (local) will refer to fuels that are used for individual heating, and a not specified previously. These primarily include organic waste and pellets (Energy

Strategy of Pécs, 2013 page 96), and will be considered as a renewable energy source. The other (outside) fuel is mentioned in (Table 19: Production characteristics of Hungarian electricity production units, 2012). According to the source table (Supply side analysis, 2013) this includes biogas, organic waste, wind farms, photovoltaic cells, geothermal and hydro powered plants. This category will also be considered as a renewable energy source.

Energy Conversion Units

The list of energy conversion units that need to be modelled is the following:

Table 20: List of energy conversion units

	Unit	Input(s)	Output(s)
community solutions	Straw-fired unit	Straw	Electricity, Heat
	Woodchip-fired unit	Wood	Electricity, Heat
	Natural gas-fired unit	Natural gas	Heat
	Geothermal	Geothermal water	Heat
	Biogas plant	Agricultural & Municipal waste	Biogas
	Hungarian grid	Mix of energy sources	Electricity
Individual solutions	Firewood boiler	Biomass (wood/woodchip)	Heat
	Natural gas-fired boiler	Natural Gas	Heat
	Electric heat pumps	Electricity, ambient heat	Heat
	Photovoltaic	Solar radiation	Electricity
	Solar collectors	Solar radiation	Heat

Source: Own edition

Community solutions

Power plants

The energy conversion units' main role in Pécs is to supply the city with heat and electricity. For this purpose there is one power plant, with several units. The Pannonpower Company operates the plant in the southern part of Pécs. It converts straw, woodchip and natural gas into electricity and heat. It is important to note that the electricity production of the power plant does not supply Pécs directly, but feeds the produced electricity to the Hungarian grid, and the consumers of the city are supplied from that grid. The plant's basic conversion system is summarized in the following table:

Table 21: Pannonpower – energy conversion

Unit	Input	Output(s)
Straw-fired unit	Straw	Electricity, Heat
Woodchip-fired unit	Wood	Electricity, Heat
Natural gas-fired unit	Natural gas	Heat, (Electricity)

Source: Own edition

For our modelling purpose, technical characteristics need to be analysed. In order to successfully model their production process, their efficiency and production capacities need to be known.

Table 22: Pannonpower units, technical details

Name	Unit of measurement	Straw-fired unit	Wood-fired unit
Utilization	<i>h</i>	7,850	7,500
Boiler efficiency (yearly average)	<i>%</i>	89	85
Boiler input	<i>MWt</i>	124	170
Maximum electricity output	<i>MWe</i>	36.2	44
Produced electricity/annum	<i>MWh</i>	267,300	387,000
Marketable electricity/annum	<i>MWh</i>	223,400	340,000
Biomass needed	<i>GJ</i>	3,391,777	4,078,721
Natural gas / oil use (for starting up)	<i>GJ</i>	2,780	5,040
Total efficiency (net)	<i>%</i>	52.3	30.5

Source: Pannon-HŐ Kft. (2006)

This data is satisfactory for the purpose of the current modelling process.

Geothermal

According to the Energy strategy of Pécs, for 2020 100 Tj energy for heating purposes is planned. This is equal to 7,778 MWh. The plant will operate all year long, except for a three week maintenance period.

Unit	Primary Input	Output
Geothermal	Geothermal water	Heat

Biogas

The energy strategy of Pécs visualizes a biogas plant that will be able to provide biogas as a fuel for public transportation, and a substitution for natural gas for heating purposes. The aggregated amount of energy that the system is will need to provide is 150 *TJ*, and 50 *TJ* for heat and transportation, respectively.

Unit	Inputs	Outputs
Biogas plant	Agricultural & Municipal waste	Biogas

Hungarian grid

During the simulation, whenever the local capacities are not capable of supplying the electricity demand, the system uses electricity from the national grid. The mix of energy sources are determined with the help of Supply side analysis (2013). Two energy mix will be used. The first one for the reference model, which simulates the year 2012, the other one for the two experimental designs (BAU and ES). The energy mixes are the following:

Table 23: Production characteristics of Hungarian electricity production units, 2012

2012	Electricity, GWh		Heat	Used Input energy, GWh					Eff.
	produced	output	output	coal	oil	N.gas	nuclear	other	
Sum of all plants in Hungary	34 394	32 047	10 148	19 419	544	26 842	47 844	7 210	0.414
Total Input energy (GWh)	101 859	% of total:		0.19	0.01	0.26	0.47	0.07	

Source: Own edition based on Supply side analysis, 2013

Using the weights of the table, and the efficiency of the system 414 *KWh* of Hungarian grid fuel is produced from the following input energy:

Table 24: Hungarian system, used input, 2012

Output	Used Input energy, KWh				
KWh	coal	oil	N.gas	nuclear	other
414	190.6	5.3	263.5	469.7	70.8

Source: Own edition

For the Business as Usual and the Energy Strategy models:

Table 25: Production characteristics of Hungarian electricity production units, 2023

2023	Electricity, GWh		Heat	Used Input energy, GWh					Eff.
	produced	output	output	Coal	Oil	N.gas	Nuclear	Other	
Sum of all plants in Hungary	47 410	44 690	9 964	16 264	536	45 023	46 389	15 406	0,442
Total Input energy (GWh)	123 618	% of total:		0.16	0.01	0.44	0.46	0.15	

Source: Own edition based on: Supply side analysis, 2013

Using the weights of the table, and the efficiency of the system 442 *KWh* of Hungarian grid fuel is produced from the following input energy:

Table 26: Hungarian system, used input, KWh, 2023

Output	Used Input energy, KWh				
KWh	Coal	Oil	N.gas	Nuclear	Other
442	131.6	4.3	364.2	375.3	124.6

Source: Own edition

Using the energy content of each fuel, the actual physical units (except for nuclear) are the following:

Table 27: Hungarian system, used input, 2023

Output	Used Input				
KWh	Coal (ton)	Oil (m3)	N.gas (m3)	Nuclear (KWh)	Other (ton)
442	0.023	0.0004	38.6	375.3	0.038

This means, that in 2023, 442 *KWh* of electricity produced by the electric system of Hungary on average uses 0.023 ton of coal, 0.0004 m3 of oil, 38.6 m3 of natural gas, 375.3 KWh of nuclear and 0.038 of other (usually biomass) sources.

Individual solutions

Natural gas-fired individual heating

The next large group of energy conversion systems is the natural gas-fired individual heating. The natural gas demand for the city of Pécs is known from Table 12.

Unit	Primary Input	Output
Natural gas-fired boiler	Natural Gas	Heat

As it was calculated in the *demand for natural gas* chapter, the 1,613 TJ energy converted and corrected for conversion losses will equal to 310,722.6 MWh. The converting energy system will use the 365,556 MWh (1,613TJ) to supply the heat demand of 310,722.6 MWh.

Firewood based individual heating

The last group of energy conversion systems is the firewood based individual heating. The firewood demand for the city of Pécs is known from Table 12.

Unit	Primary Input	Output
Firewood boiler	Biomass (wood/woodchip)	Heat

As it was calculated in the *demand for firewood* chapter, the 556 TJ energy converted and corrected for conversion losses will equal to 100,389 MWh. The converting energy system will use the 154,444 MWh (556 TJ) to supply the heat demand of 100,389 MWh.

Electric heat pumps

The proposed energy system of Pécs would contain numerous heat pumps. According to the energy strategy of Pécs, one out of every 10th user will use a heat pump. The model will contain a virtual, aggregated version of all heat pumps. They will be introduced along with photovoltaic cells to supply them with electricity when possible. The 350 TJ (97,222 MWh) heat will supply the houses currently on individual, natural gas based heating.

Unit	Input	Output
Electric heat pumps	electricity, ambient heat	Heat

Photovoltaic

The photovoltaic cells will be on individual houses, or community buildings according to the energy strategy of Pécs. Their primary objective will be to supply the installed electric heat pumps demand for electricity. The aggregated electricity production expected from the cells is 55 TJ. The model will obtain the exact specifications during the model translation phase and the calibration process.

Unit	Input	Output
Photovoltaic	Solar radiation	Electricity

Solar collectors

Solar collectors will supply heat to individual and public buildings. Their main purpose is to reduce the need for fossil based fuel for space heating a sanitary hot water purposes. The aggregated heat produced will be expected to reach 60 Tj yearly.

Unit	Input	Output
Solar collectors	Solar radiation	Heat

Model translation

After determining the data needed to model the energy system of Pécs, the actual model translation will take place. In this step, the collected data will be fed to the chosen modelling framework, energyPRO. Changes to the data type and structure will be made when needed. The goal of the process is to get the model ready for the verification and validation phases.

The model translation process will consist of the following steps:

Step	Category	Sub-process
1	Demand side	Heat
		Electricity
		Transportation
2	Supply side	Energy sources
		Energy conversion units

All of the collected data will be fed into the modelling framework. The main categories are the hourly distribution of energy demand for electricity, heat and transportation, the input-output structure of all energy conversion units and the data for the types of fuels the system uses.

Since the model translation is purely technical, it is placed in the appendices of the dissertation. Please check Appendix I. for details of this step.

Steps VI. – VII. Verification and Validation

Steps of Simulation (a.)	
I.	Problem formulation
II.	Setting of objectives and overall project plan
III.	Model conceptualization
IV.	Data collection
V.	Model translation
VI.	Verified?
VII.	Validated?
VIII.	Experimental design
IX.	Production runs and analysis
X.	More runs?
XI.	Documentation and reporting
XII.	Implementation

Verification and validation

According to Banks et al. (2014), with complex models it is very difficult to translate the model successfully without a good deal of debugging. The verification process will check whether the computer program used for simulation works according to the intent with the model built in. If needed, calibration will take place, which is a correction of the data in order for the model to represent the actual system as closely as possible. If the model is calibrated, it can be validated, checked against real life data. If the system represents the real life system accurately, it can be used for further experiment and research.

Calibration process

The calibration of the model will consist of comparing the modelled data with actual data from the year 2012, and adjusted accordingly.

Heat duration curve for district heating

The duration curve for the district heating is important, since the model should be able to simulate the heat needed from district heating for years with various temperatures. The temperature values and the actual duration curve for the district heating values were obtained from the district heating supplier of Pécs (PÉTÁV). This is tested against the duration curve obtained from the method developed at data collection / demand side / heat / determining the

distribution of heat demand based on external. During the process, the duration curve is divided into two sections.

Section a.) Left side of the duration curve, where the district heating and sanitary hot water are both needed.

Section b.) Right side of the duration curve, where only sanitary hot water is needed.

The division between the two will be at $15^{\circ} C$. The goal of the calibration is to obtain a section a of a duration curve, where the average difference between corresponding values is under 10% with a standard deviation under 5%

The number of hours when the temperature was below $15^{\circ} C$ was 5009. The duration curve will be divided at hour 5009. The following graph demonstrates the division:

Figure 24: Hypothetical heating demand division

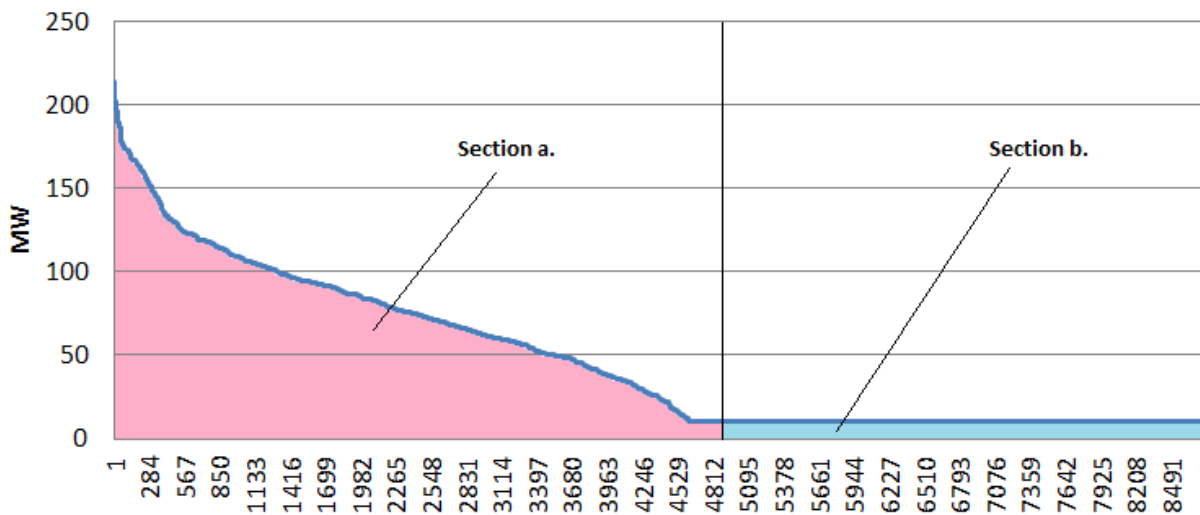

Source: Own edition

The average difference between the corresponding values is calculated the following way:

$$\bar{d} = \frac{1}{k} \cdot \sum_{h=1}^{h=k} \left| \frac{ActN_h - ModN_h}{ModN_h} \right|$$

where

\bar{d}	average difference between corresponding values
k	number of hours when the temperature was below 15 ° C within the modelled time period
$ActN_h$	actual normalized duration curve value at hour h
$ModN_h$	modelled normalized duration curve value at hour h

The standard deviation of the differences is calculated the following way:

$$\sigma_d = \sqrt{\frac{1}{k} \sum_{h=1}^{h=k} \left(\bar{d} - \left| \frac{ActN_h - ModN_h}{ActN_h} \right| \right)^2}$$

where

σ_d	standard deviation of the differences
\bar{d}	average difference between corresponding values
k	number of hours when the temperature was below 15 ° C within the modelled time period
$ActN_h$	actual normalized duration curve value at hour h
$ModN_h$	modelled normalized duration curve value at hour h

When comparing the two duration curves normalized values are used. The first step is to compare the modelled and the actual normalized duration curve, the second step is to adjust the modelled normalized duration curve to closely follow the actual normalized duration curve. Comparing the normalized duration curve of the model with the actual normalized duration curve for the year 2012 for section a, yields the following graph²⁴:

²⁴ Please note that the temperature values on the x-axis are listed in ascending order, and do not necessarily pair up with the actual heat demand values.

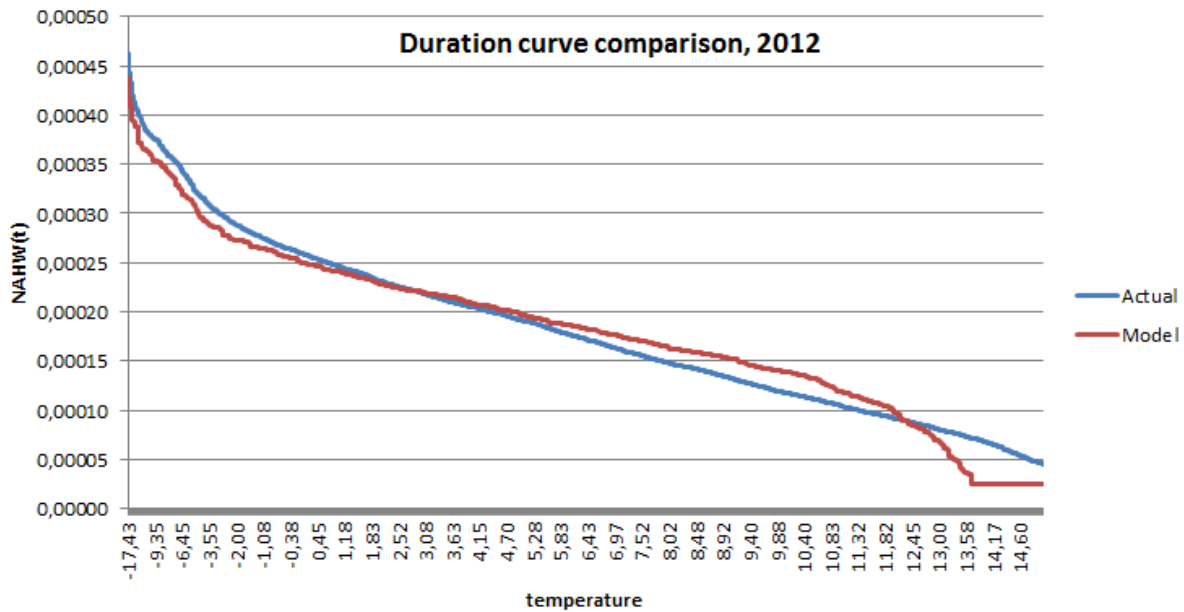

The average difference between the corresponding values is 19.26% with the standard deviation of 39.51%. It can be seen that the model underestimates temperature values under $0^{\circ} C$, overestimates for temperature values between $0^{\circ} C$ and $12,45^{\circ}$, and underestimates for temperature values between $12,45^{\circ} C$ and $15^{\circ} C$.

The first problem to be solved is the underestimation for values over $12,45^{\circ} C$. This could be due to the fact that the non-heating period within the model is longer than in the actual heating system. In order to correct this, the non-heating period will be shortened to only the summer months. This means, that if needed the district heating system provides heat in May and September also.

	Start	End
Old non-heating period	1st of May	9th of October
New non-heating period	1st of June	1st of September

The new graph after recalculation:

Figure 25: Duration curve comparison I, 2012

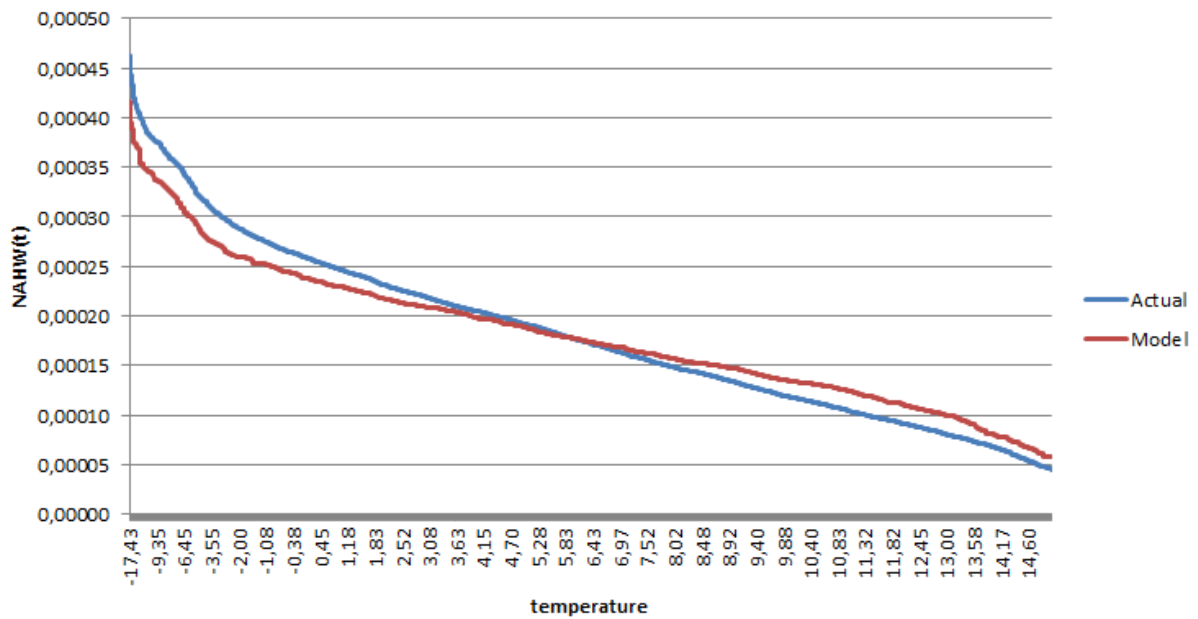

Source: Own edition

The average difference between the corresponding values is 9.52% with the standard deviation of 5.66%. The first step was successful. The next step is to solve the under and over estimation of values.

The model allocates more²⁵ demand to higher ambient temperatures and less demand for lower temperatures. This can be corrected by lowering the difference between the external air temperature at which heating is switched on and the internal air temperature the spaces need to be heated up to (A_s and A_l). The current values for the two variables are $15^\circ C$ and $21^\circ C$. By reducing the difference between the two values, the model will reduce the amount of heat it allocates for higher temperatures, since the relative amount of heating needed (RH_t) will be affected more. The new values are

$$A_s: \quad 15^\circ C$$

$$A_l: \quad 17^\circ C$$

²⁵ more than the actual

The new graph after recalculation:

Figure 26: Duration curve comparison II, 2012

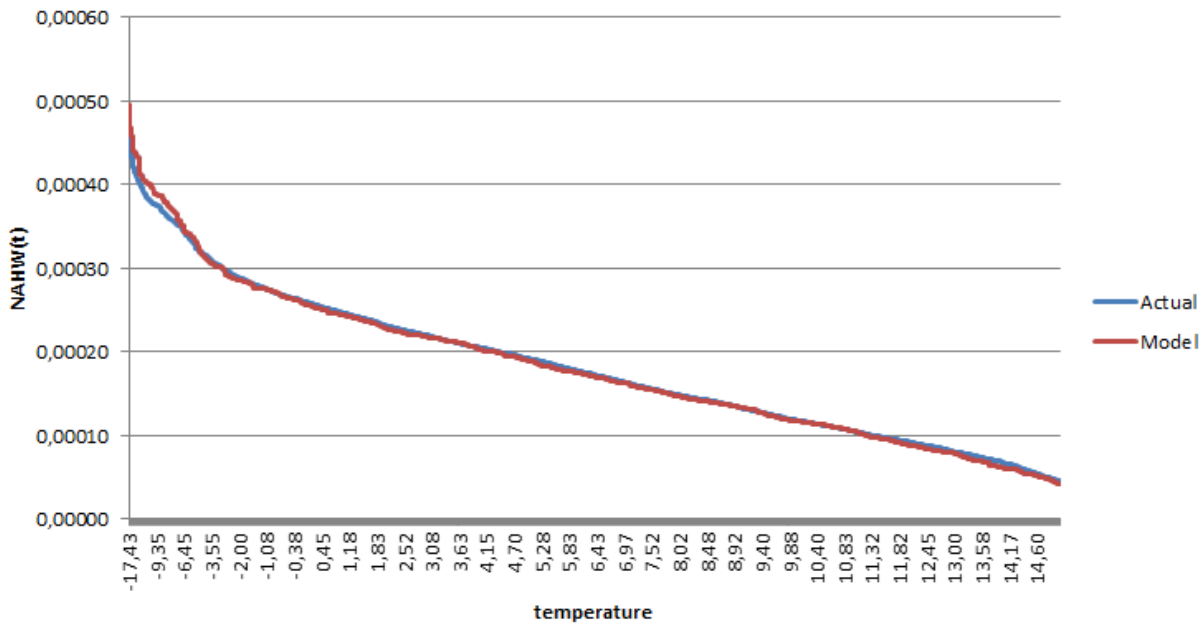

Source: Own edition

The average difference between the corresponding values is 2.05% with the standard deviation of 2.26%.

The model seems to simulate the duration curve for heating periods very closely. Although these values satisfy the goal of the calibration process, after expert consultation with the technical deputy-manager and the commercial deputy-manager of PÉTÁV, the district heating firm, a last correction is going to be made.

It has to be taken into account that the demand for district heating can vary significantly during late spring and late autumn, since the habitants of the buildings can decide when they would like to stop/start the service. This occurs mostly between $10^{\circ} C$ and $15^{\circ} C$. The rate depends on how suddenly the warm or the cold whether comes in. When the temperature increases (decreases) gradually the buildings also request to stop (start) the service gradually. When the temperature increases (decreases) within a couple of days, all the buildings request to stop (start) the service within a couple of days. Since the rate of the change of the weather is extremely hard to forecast, a solution will be chosen that will avoid the extreme effects of the described events. It will be assumed that the number of buildings that request to stop the service will decrease exponentially between $10^{\circ} C$ and $15^{\circ} C$, and

exponentially increase between $15^{\circ} C$ and $10^{\circ} C$. This is done by multiplying the adjusted relative amount of heating (ARH_t) values at time steps when the temperature is between the two values.

The model will assume that at $10^{\circ} C$, no building is going to request the turning off of the district heat. As the temperature rises, the ratio of buildings still requesting heat is going to exponentially decrease. The constant (0.96) is chosen so the exponential decrease is not radical. The new values for ARH_t 's where the temperature is higher than $10^{\circ} C$, is

$$ARH_{t1} = ARH_t \cdot \frac{1}{0.96^{(10-temp_t)}}$$

where

ARH_t adjusted relative amount of heat at time step t

$temp_t$ ambient temperature at time step t

For ARH_t values where the ambient temperature is lower than or equal to $10^{\circ} C$ the values remain unchanged. The new graph after recalculation:

Figure 27: Duration curve comparison III, 2012

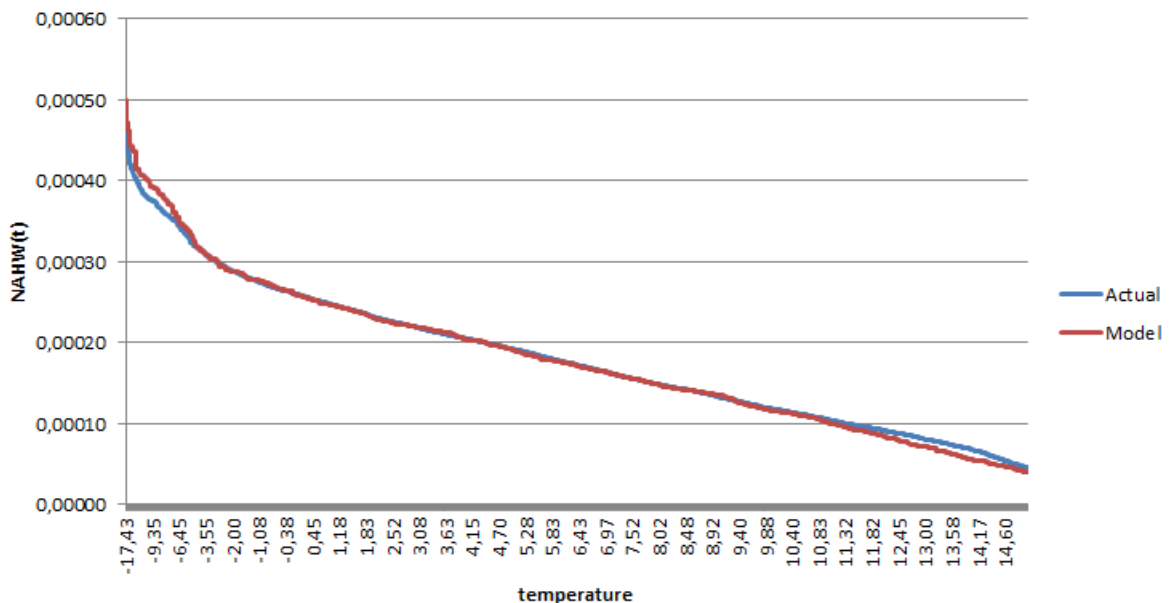

Source: Own edition

The average difference between the corresponding values is 3.67% with the standard deviation of 5.69%. Although these values are higher than the previous ones, the last modification will ensure that the model will give close approximation of the actual district heating values for a quick and a gradual decrease (increase) in the demand for district heating during transition between heating and non-heating periods.

The second step is to distribute the total district heating demand among the duration curve. The modelled and the actual duration curves:

Figure 28: Duration curve comparison IV, 2012

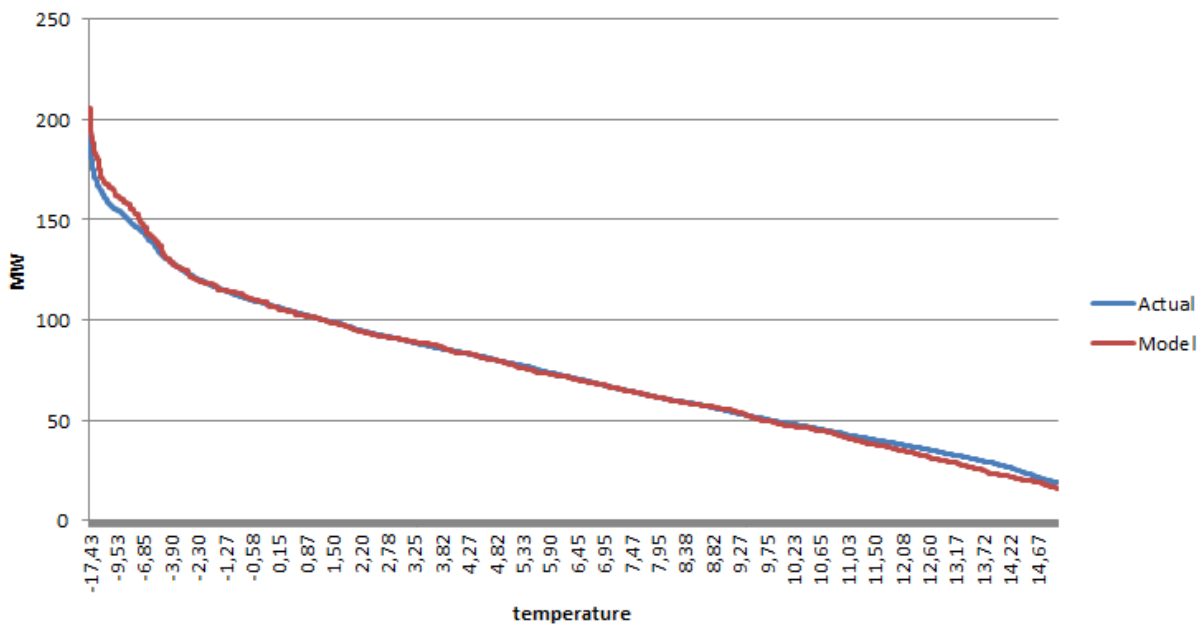

Source: Own edition

The only part that can cause problems is the peak demand. According to the experts from the district heating company, the maximum heat load that the system uses is 188 MW, which can be reached at around $-11^{\circ} C$. Even if the temperature falls below $-11^{\circ} C$, the district heating company only buys 188 MW from the power plant, which supplies the heat. The model simply reduces the amounts that are over 188 MW to 188 MW.

The new graph after recalculation:

Figure 29: Duration curve comparison V, 2012

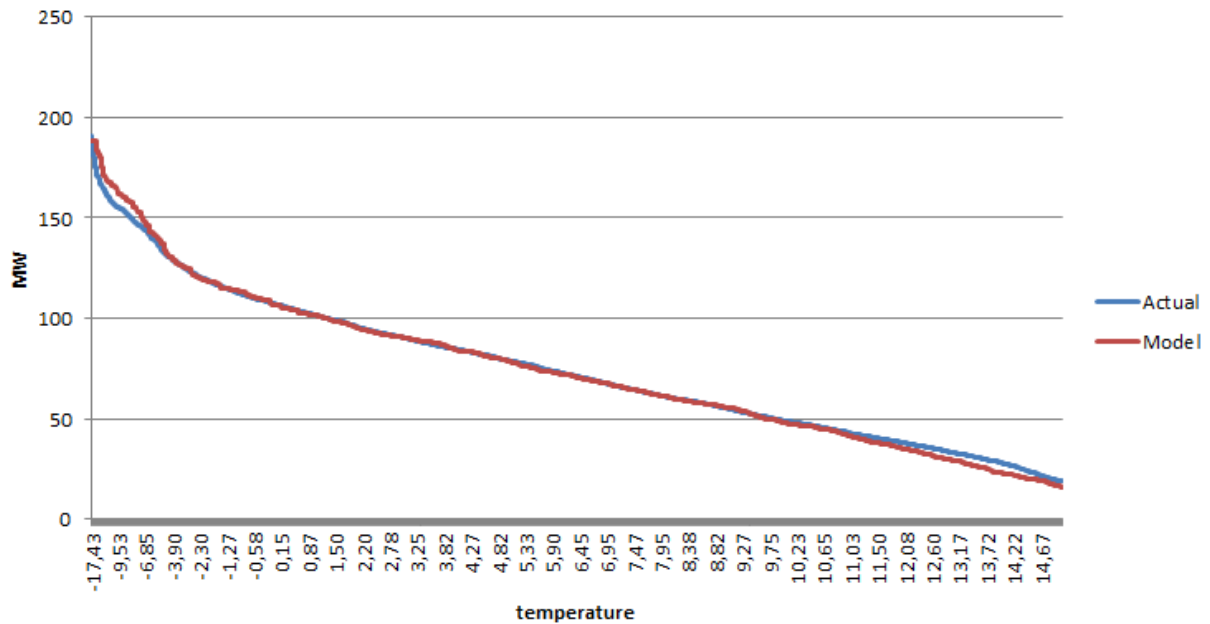

Source: Own edition

The final average difference between the corresponding values is 3.66% with the standard deviation of 5.69%.

Validation process

Validation usually is achieved through the calibration of the model, an iterative process of comparing the model against actual system behaviour and using the discrepancies between the two, and the insights gained, to improve the model. This process is repeated until model accuracy is judged acceptable (Banks et al, 2014). The validation process will analyse the input values of the model, and compare them to the actual input of the system.

Priority of production units

The priority of the production units is important when two or more energy conversion is available to supply a demand. The priority used for the reference model is the following:

Table 28: Priority of energy conversion units for the reference model

Priority	Energy Conversion Unit
1	Pannon Woodchip
2	Pannon Natural Gas (Oil + Natural gas)
3	Boiler Wood
4	Boiler Ngas
4	PB gas bottles
4	Boiler Other
5	Bus (local)
5	Bus (p2p)
5	Diesel cars
5	Petrol cars
5	Petrol Small & Medium Trucks
5	Diesel Small & Medium Trucks
5	Large Trucks
6	Hungarian grid

Source: Own edition

Heat duration curve for district heating

After the calibration process with the help of the 2012 data, the validation will be made by developing the *section a* of the duration curve with the temperature data from 2013. This will be tested against the actual duration curve from 2013:

Figure 30: Duration curve comparison VI, 2012

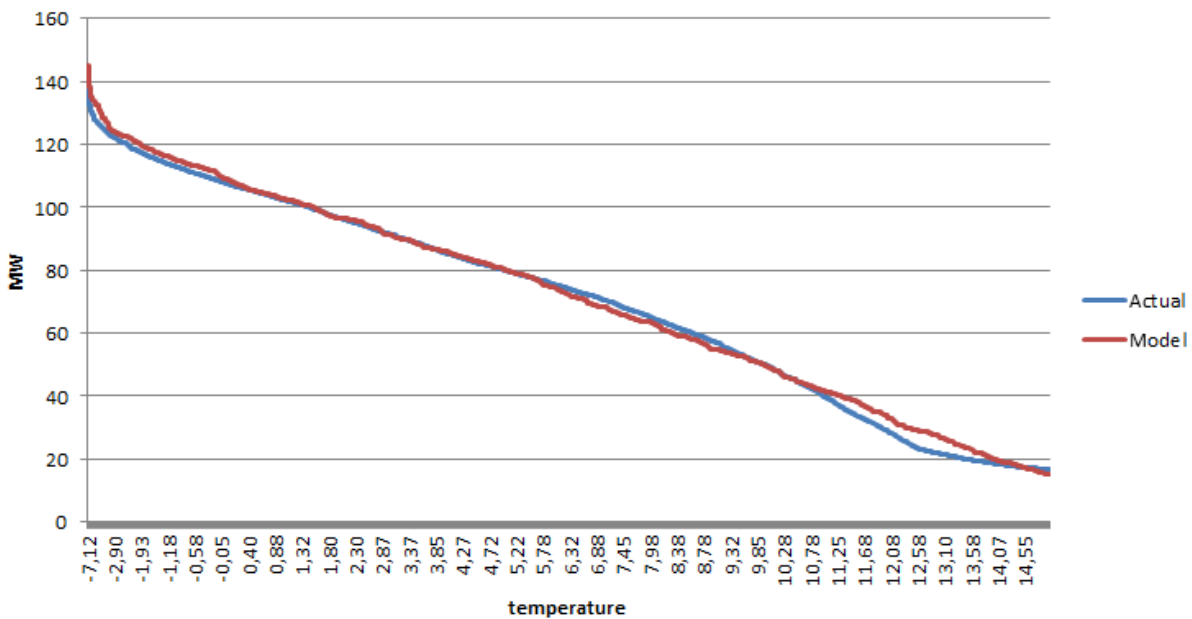

Source: Own edition

The average difference between the corresponding values is 3.87% with the standard deviation of 5.16%. It can be seen, that there is a bigger drop in the graph at temperatures above 10 ° C. This can be explained with the sudden change in weather at the transition period between heating and non-heating season. The model handled the phenomenon by staying below an average difference of 4%.

The model developed gave a very close approximation for the duration curve of the district heat demand for heating season.

Section b.)

The estimation of the right hand side of the duration curve is a less complex problem. According to the expert opinion of the district heating company of Pécs, a constant load is a satisfactorily close approximation. This method is also widely used for research purposes.

Graphical layout of the reference model

The graphical layout will consist of three sub-systems. The base system (district heating and electricity) will include the CHP units and the Hungarian grid on the supply side, and the electricity and district heat demand on the demand side. The two individual heating systems will display the natural gas fired and the wood fired boilers and their respective heat demands. The transportation sector will consist of each type of vehicle used within the system.

Figure 31: Graphical layout of the reference model

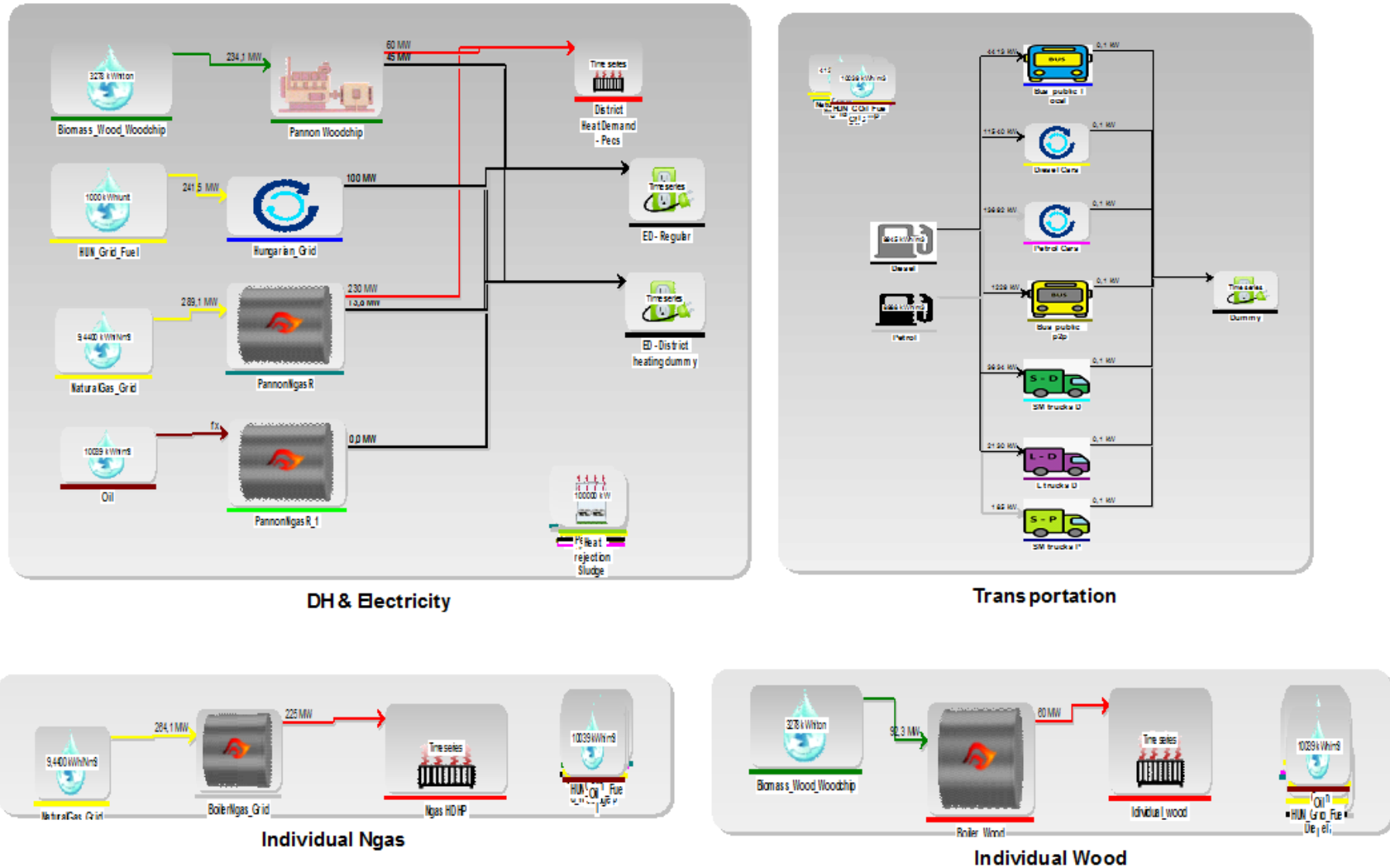

Validation of the Reference model

The validation of the district heat demand individual heating systems, electricity demand and fuel for transportation was made by comparing the aggregated values within the system for the modelled and the actual data. Sources for the reference data can be found in Table 29, and the results of the comparison in Table 30.

Table 29: Sources for validation of the Reference model

District heat demand	1 488 TJ	Production schedule, PÉTÁV (DH operator) (PÉTÁV, 2012)
Peak district heat demand	191 MW	
Heat production of CHP unit (biomass)	1 068 TJ	Production schedule, PÉTÁV (DH operator) (PÉTÁV, 2012) and Supply side analysis (2012)
Heat production of CHP unit (natural gas)	420 TJ	Supply side analysis (2013)
Natural gas demand (Individual heating systems)	1 316 TJ	Energy Strategy of Pécs (2013)
PB demand (Individual heating systems)	300 TJ	
Wood demand (Individual heating systems)	105 TJ	
Other demand (Individual heating systems)	126 TJ	
Electricity demand	1 620 TJ	Energy Strategy of Pécs (2013)
Electricity production of CHP unit (biomass)	N/A	N/A
Electricity production of CHP unit (natural gas)	25.2 TJ	Supply side analysis (2013)
Fuel use of vehicles (petrol)	432 TJ	Energy Strategy of Pécs (2013)
Fuel use of vehicles (diesel)	724 TJ	

Source: Own edition

Table 30: Validation of the 2012 Reference model

	Actual	Modelled	Diff. Unit	Diff. %
District heat demand (TJ)	1 488	1 497	9.0	0.6077
Peak district heat demand (MW)	191	188	2.9	-1.5183
Heat production of CHP unit (biomass) (TJ)	1 068	1 052	-17.2	-1.6133
Heat production of CHP unit (natural gas) (TJ)	420	422	2.4	0.5623
Natural gas demand (Individual heating systems) (TJ)	1 316	1 321	4.8	0.3635
PB demand (Individual heating systems) (TJ)	300	302	2.1	0.6848
Wood demand (Individual heating systems) (TJ)	105	106	0.6	0.5854
Other demand (Individual heating systems) (TJ)	126	127	1.2	0.9689
Electricity demand (TJ)	1 620	1 625	4.9	0.3048
Electricity production of CHP unit (biomass) (TJ)	N/A	789	N/A	N/A
Electricity production of CHP unit (natural gas) (TJ)	25.2	25.3	0.1	0.5629
Fuel use of vehicles (petrol) (TJ)	432	433	0.5	0.1233
Fuel use of vehicles (diesel) (TJ)	724	722	-1.6	-0.2216

Source: Own edition

The results obtained from the simulation of the reference model are very close to the actual values, the differences being invariably below 2% (mostly below 1%). The results clearly confirm that the developed model represents the energy system very closely and that it is, in consequence, satisfactory to conduct simulations for future energy systems.

The following chapter will use the validated model's simulation structure, and use it to simulate two potential paths for the energy system of Pécs, with special emphasis on the set hypotheses. Figure 32 illustrates the graphical layout of the validated reference model.

Figure 32: Graphical layout of the reference model

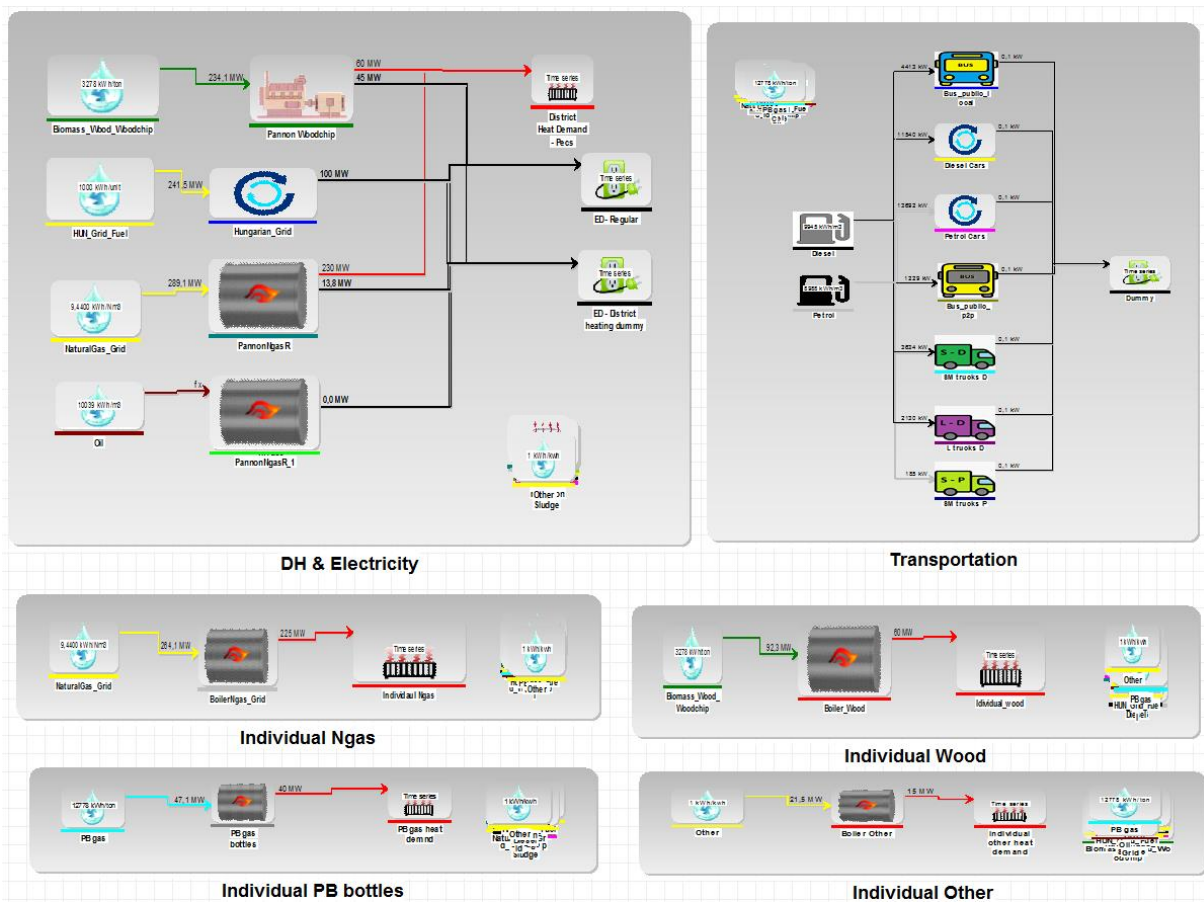

Source: Own edition

Chapter 7 – Model simulation

The first part of Chapter 7 uses the validated reference model and uses it to simulate two potential future scenarios for the city of Pécs. The two alternatives will be the 2020 energy system of Pécs, if they do not implement the specific steps determined in the energy strategy, called (BAU, business as usual), and the 2020 energy system of Pécs, if they do implement all the proposed changes (called ES – Energy Strategy). The second part of the chapter will compare the obtained results in light of the set hypotheses.

Steps VIII. – IX. Experimental design and Production runs and analysis

Steps of Simulation (a.)	
I.	Problem formulation
II.	Setting of objectives and overall project plan
III.	Model conceptualization
IV.	Data collection
V.	Model translation
VI.	Verified?
VII.	Validated?
VIII.	Experimental design
IX.	Production runs and analysis
X.	More runs?
XI.	Documentation and reporting
XII.	Implementation

Experimental design

In this phase, the alternatives that are to be simulated must be determined (Banks et al, 2014). The two alternatives will be the 2020 energy system of Pécs, if they do not implement the specific steps determined in the energy strategy, called BAU (business as usual), and the 2020 energy system of Pécs, if they implement all the proposed changes.

Pecs 2020, Business as usual (BAU)

The design of the energy system for Pécs, if no steps are implemented from the energy strategy will practically have the same production structure as the reference model developed for the city for 2012. Please refer to Table 20: List of energy conversion units for the list for

the energy conversion units for the reference system. The only difference is the 2013 instalment of a straw fired biomass unit (Pannonpower, 2013).

The demand of the system will be the same as for the reference model, since the business as usual model will not take the proposed structural changes into consideration. The external values (temperature values, solar radiation values) used for simulation will be the same as for the reference model. The following section will show the parts of the model where modification is needed from the reference model.

Change in priority of production units

Table 31: Priority of energy conversion units for the BAU model

Priority	Energy Conversion Unit
1	Pannon Woodchip
2	Pannon Natural Gas (Oil)
3	Pannon Natural Gas (NGas)
4	Boiler Wood
5	Boiler Ngas
5	PB gas bottles
5	Boiler Other
6	Bus (local)
6	Bus (p2p)
6	Diesel cars
6	Petrol cars
6	Petrol Small & Medium Trucks
6	Diesel Small & Medium Trucks
6	Large Trucks
7	Hungarian grid

Source: Own edition

The city of Pécs will favour the use of biomass when producing energy. The new straw fired unit will be the primary production unit within the plant.

Change in natural gas fired unit of the power plant

After the introduction of the straw fired unit in the power plant, the natural gas fired unit no longer produces electricity, but merely serves as a back-up unit for periods when the two biomass fired units cannot supply the needed heat demand for any reason. The new data for the unit:

Table 32: New setup for natural gas fired unit

Pannon Ngas	Type	Volume	
Input 1	Natural Gas	272.4	MW
Input 2	Oil	Natural gas * 0,16	MW
Output 1	Heat	230	MW
Total efficiency of Plant	72.6%		

Source: Own edition

The input value for the unit changes accordingly:

$$\text{input} = \frac{230 \text{ MW}}{0.726} = 316.8 \text{ MW}$$

The 316.8 MW of input will be divided into oil and natural gas demand, similarly as for the original unit:

$$\text{input(oil)} = 316.8 \text{ MW} \cdot 0.14 = 44.4 \text{ MW}$$

$$\text{input(Ngas)} = 316.8 \text{ MW} \cdot 0.86 = 272.4 \text{ MW}$$

The input for oil will be modelled as 16% of the natural gas fuel demand, as it was determined at the model transition phase of the original unit.

Change in aggregated demand values

The demand of the system will be the same as for the reference model, since the business as usual model will not take the proposed structural changes into consideration. Only the aggregated demand for energy for transportation will be taken into consideration, since the minor decrease is independent from the proposed structural changes.

Energy demand	2012	2020BAU
Transportation TJ	1156	1050

District heating dummy (electricity demand)

The dummy electricity demand will be recalculated with the same steps as described at model translation / demand side / electricity / group 3: district heating dummy, but with an updated input table:

Table 33: Updated input table (CHP units)

CHP units	MW	Electricity	Heat
Pannon Straw		31,5	70
Pannon Woodchip		45	60
Sum		76,5	130

Graphical layout of the BAU model

Figure 33: Graphical layout of the BAU model

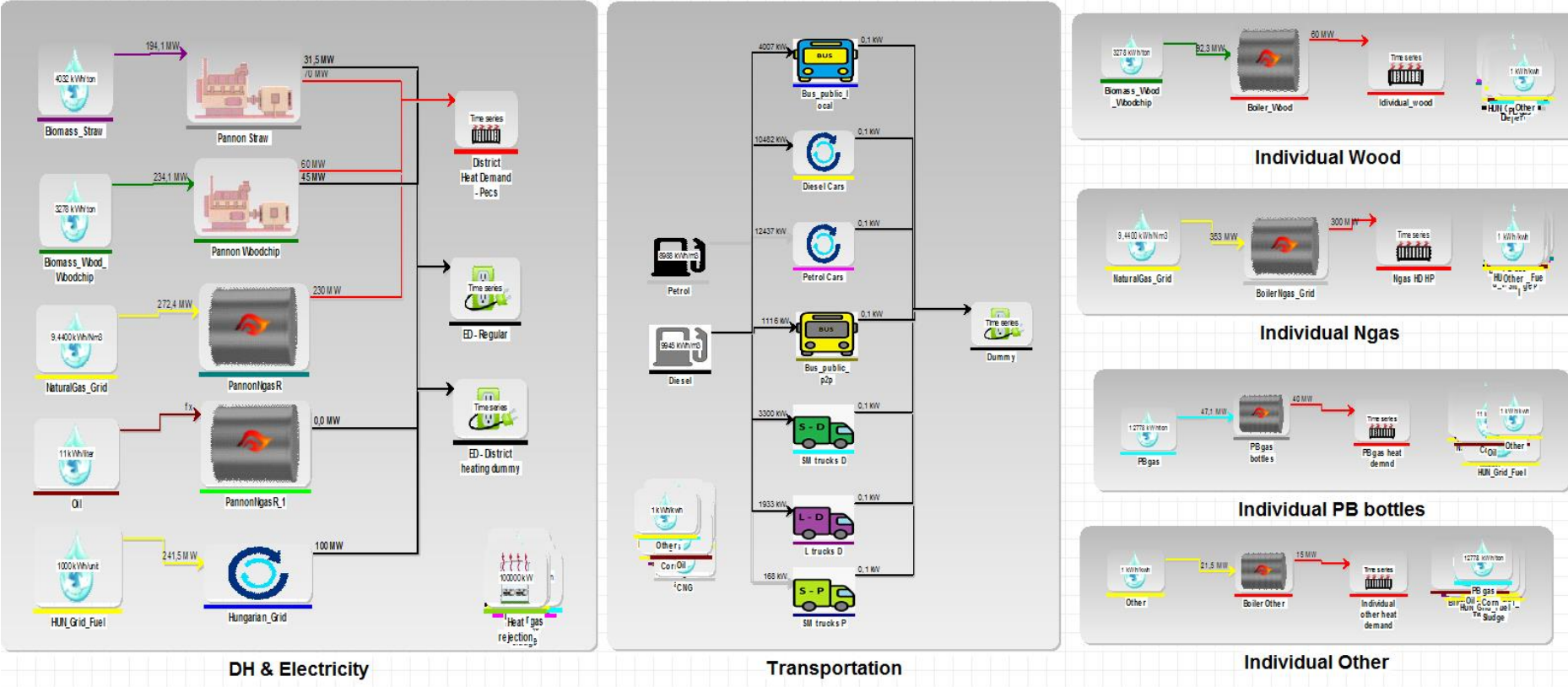

The design of the energy system for Pécs, if all the suggestions are implemented from the energy strategy will have a very different production structure than the reference model developed for the city for 2012. Please refer to Table 20: List of energy conversion units for the list for the energy conversion units for the reference system. The energy conversion units marked at the *alternative* column will be used. In this chapter, the changes from the Pécs 2020, business as usual model will be discussed.

Change in priority of production units

Table 34: Priority of energy conversion units for the BAU model

Priority	Energy Conversion Unit
1	Photovoltaic
2	Solar collector
3	Geothermal
4	Electric heat pumps
5	Biogas Plant
6	Pannon Straw
7	Pannon Wood
8	Boiler Biogas
9	Boiler Wood
9	Boiler Ngas
9	Bus (biogas)
9	Pannon Natural Gas (Oil + Natural gas)
9	Bus (local)
9	Bus (p2p)
9	Diesel cars
9	Petrol cars
9	Petrol Small & Medium Trucks
9	Diesel Small & Medium Trucks
9	Large Trucks
10	Hungarian grid

Source: Own edition

The new alternative and/or renewable energy conversion units will have a higher priority in the production strategy. Please note that the priority is only important if two energy conversion units are supplying the same demand.

The demand of the system will also change, since the Pécs 2020 ES model will use the aggregated demands forecasted in the energy strategy of Pécs. The external values (temperature values, solar radiation values) used for simulation will be the same as for the reference model. The following section will show the parts of the model where modification is needed from the reference model.

Change in aggregated demand values

Table 35: Change in aggregated demand values

Energy demand, TJ	2012	2020BAU
Electricity	1,620	1,605
Heat	3,360	3,095
Power Plant (DH)	1,488	1,880
Individ. Ngas	1,316	1,050
Individ. Wood	556	165
Transportation	1,156	1,050
SUM	6,136	5,655

Source: Own edition based on Energy strategy, 2013

A shift from individual natural gas heating and individual wood fired boilers towards district heating can be seen. The decrease in the energy demand for transportation is minor.

District heating dummy (electricity demand)

The calculation method is the same as for the reference and the business as usual models. The input table is the same as for the business as usual model:

CHP units	MW	Electricity	Heat
Pannon Straw		31.5	70
Pannon Woodchip		45	60
Sum		76.5	130

The new units with a higher priority now include the geothermal unit ($HDp(t)$) and the photovoltaic unit ($EDp(t)$). The calculation method is exactly the same as for the previous models. For details, please refer to model translation / demand side / electricity / group 3: district heating dummy.

Change in structure of transportation

The introduction of biogas fuelled buses reduces the need for diesel fuelled vehicles. With the energy content of 6 *KWh/Nm³* for biogas, the 50 *TJ* (13,889 *MWh*) of fuel produced for transportation purposes by the biogas plant is equal to

$$\frac{13,889 \text{ MWh}}{6 \text{ KWh/Nm}^3} = 2,314,815 \text{ m}^3$$

According to (Ghazali et al, 2012), the average consumption of biogas fuelled buses at a Baltic biogas bus project was 8 *Nm³/10km*. According to a calculation based on table 2. a.) in (Energy strategy of Pécs, 2013 pp 75.) the total kilometres run by public local transportation buses were 8,813,765 *km/year*. This means that at 8 *Nm³/10km* of biogas consumption, the 2,314,815 *m³* fuel would be enough to cover for 32.83% of total kilometers. The fuel consumption of Public transportation buses (local) will be reduced by 32.83%, and biogas buses introduced to the system.

Graphical layout of the ES model

Figure 34: Graphical layout of the ES model

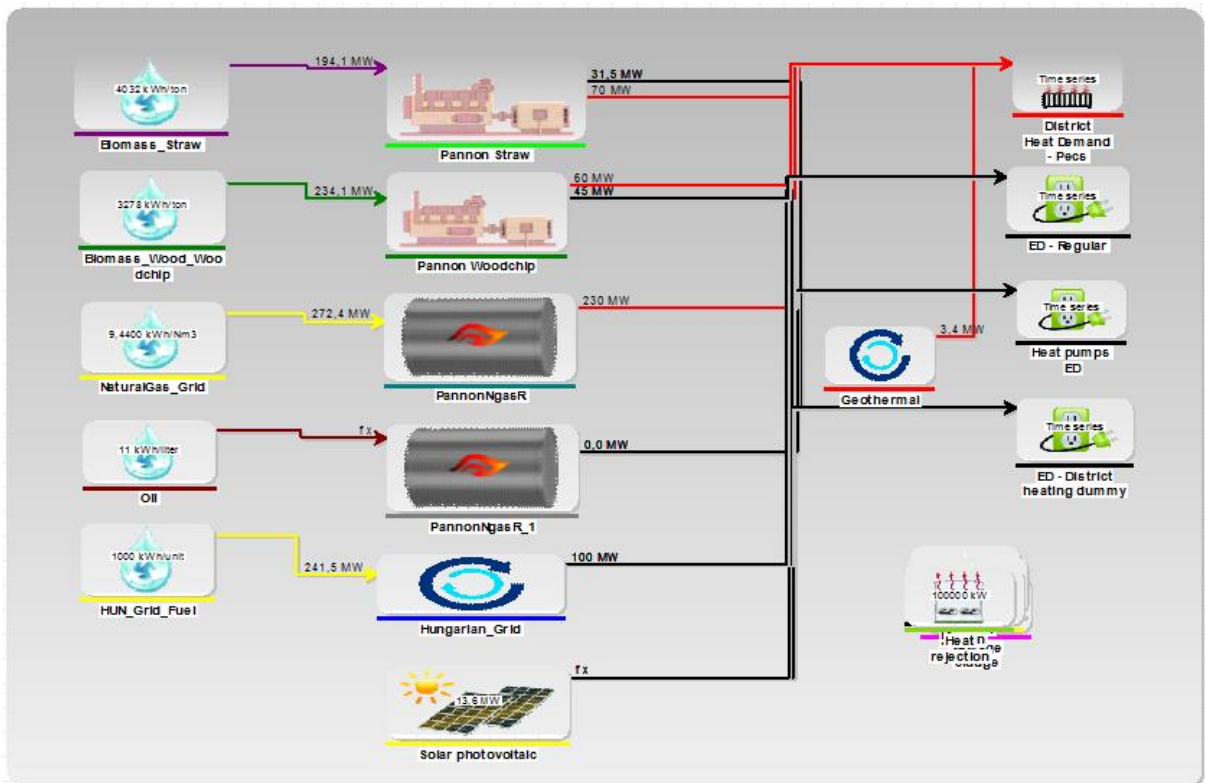

DH & Electricity

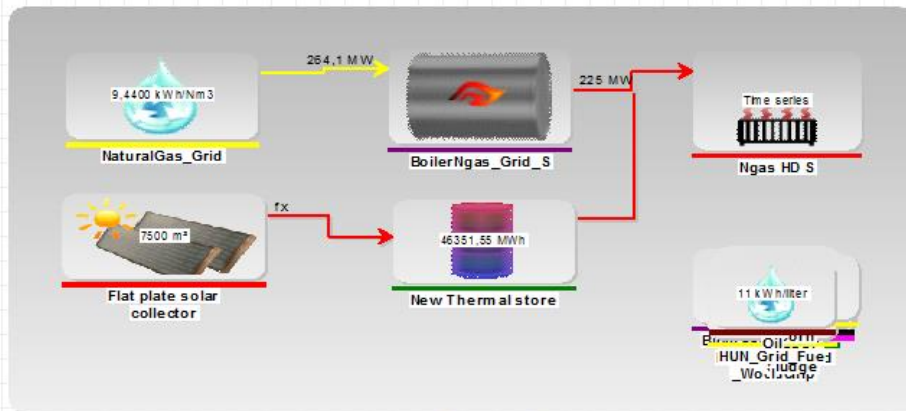

Individual Ngas - Solar

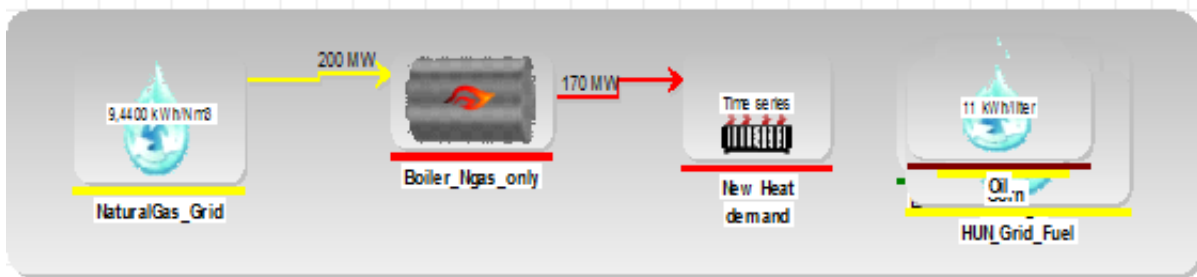

Individual Gas only

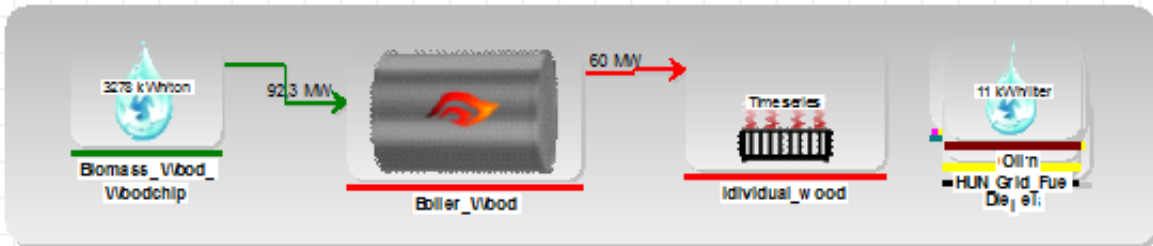

Individual Wood

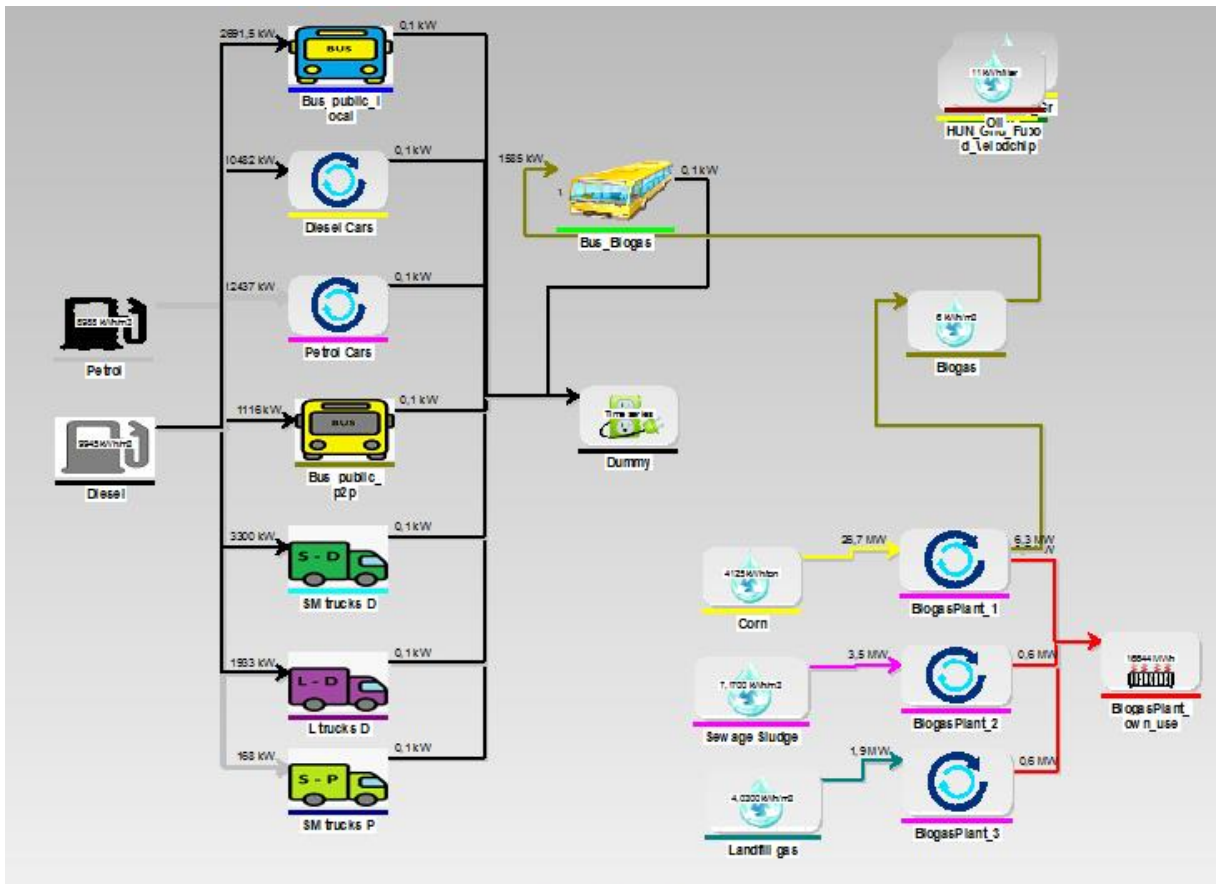

Transportation

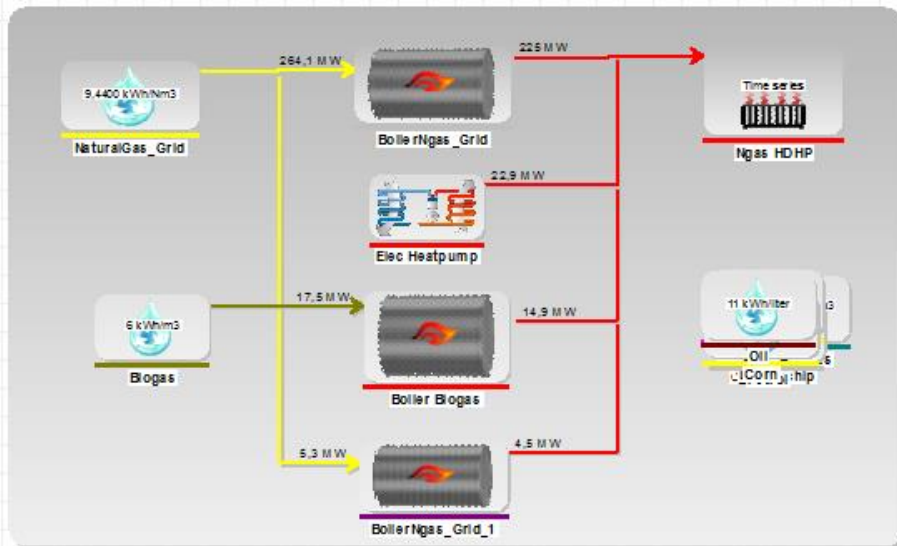

Individual Ngas - HP

Production runs and analysis

Both the Business as Usual and the Energy Strategy models are run for the duration of one hypothetical year (2020). The used amount of input of the complex systems are determined. This section compares the two developed model in terms of the hypotheses set in Chapter 6.

Comparison of the two models

After developing a validated model, the proposals of the energy strategy of Pécs were built in and compared to a scenario where no action is taken. The two scenarios are named Energy Strategy (ES) and Business as Usual (BAU). The simulated year in this case is 2020, since the implementation phase could take years. The change in the demand characteristics of the city are also taken into consideration.

Figure 35 demonstrates a six day period during November in the district heating and electricity system. The two graphs show the simultaneous use of heat and electricity hour by hour. The priority of the use of renewable energy sources (geothermal and biomass for heat, and solar for electricity) can be seen in both cases.

Figure 35: Example run

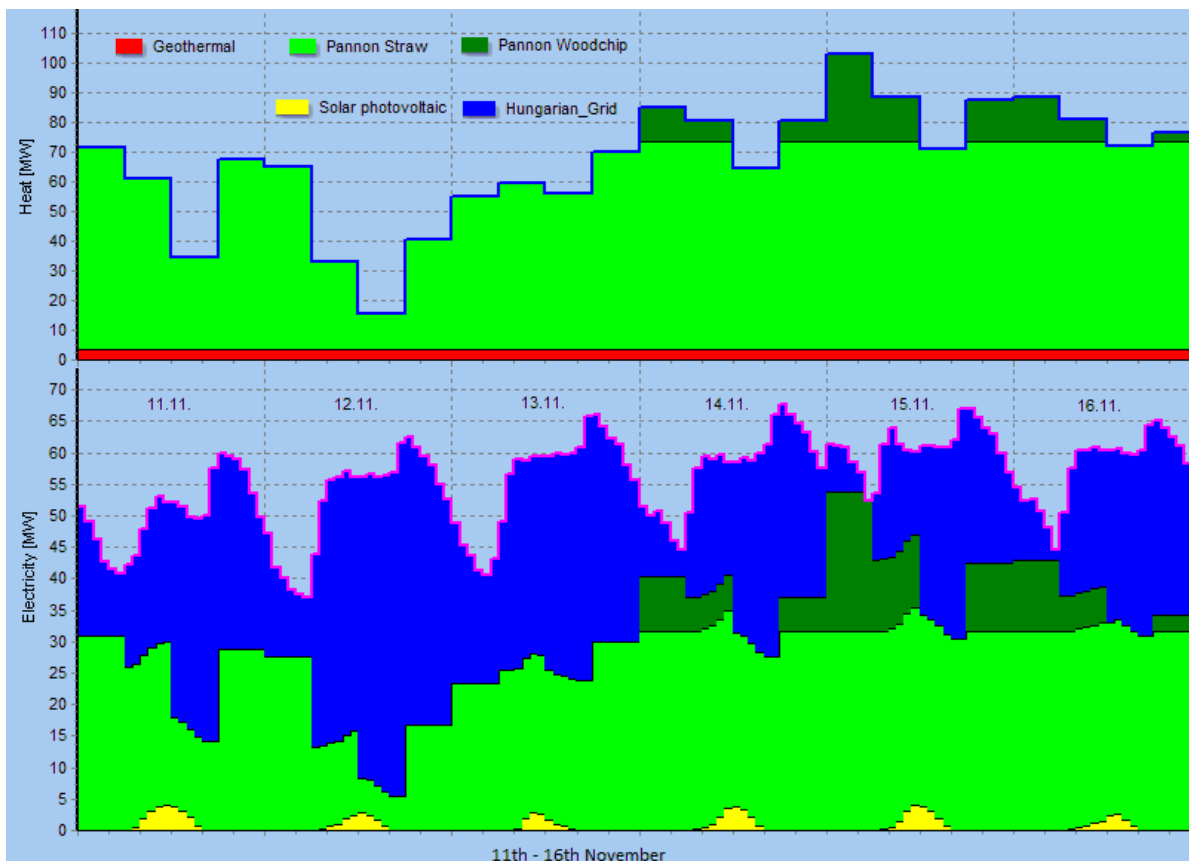

Fuel use

The direct fuel use is the input of the system that is used locally. The indirect fuel use is the fuel input of the Hungarian electricity production system proportional to the electricity supply to the city.

The first aspect of comparison is the rate of total energy dependency which will be determined by comparing the proportion of external and local fuel used in the system. Table 36 shows that the implementation of the steps defined in the energy strategy of Pécs changed the fuel demand of the system radically. The expansion of the district heating system has many consequences such as the reduced need for natural gas (-29.26%, primarily because of the expansion involving buildings formerly fired with natural gas), an increase in the use of local biomass (33.87% taking all three biomass types into consideration) and the increase in locally produced electricity (reducing the need for other external source fuels such as coal and nuclear fuels). The major decrease in the natural gas demand is also due to the fact that the use of renewable energy sources (solar and air) primarily target the individual buildings. Please note that the table separates the primary energy use of petroleum into diesel, petrol and oil.

Table 36: Comparison of fuel consumption of business as usual and energy strategy models

TJ	Business as usual	Energy strategy	Difference TJ	Difference %	Source	RES
Biomass (straw)	3 201.1	3 279.0	77.9	2.43	Local	Yes
Natural Gas	2 084.4	1 390.9	-693.5	-33.27	External	No
Biomass (wood)	1 432.6	1 902.9	470.3	32.83	Local	Yes
Diesel + Petrol	1 108.9	1 058.8	-50.2	-4.52	External	No
Nuclear	877.1	753.1	-124.0	-14.14	External	No
PB gas	271.8	0.0	-271.8	N/A	External	No
Coal	311.5	267.4	-44.0	-14.14	External	No
Other	114.5	0.0	-114.5	N/A	Local	Yes
Other (external)	131.1	112.6	-18.5	-14.14	External	Yes
Oil	20.5	31.3	10.9	53.00	External	No
Solar + Geothermal + Air	0.0	439.0	439.0	N/A	Local	Yes
Municipal & Agricultural waste	0.0	2 520.3	2 520.3	N/A	Local	Yes
Total	95 53.6	11 755.4	2 201.8	23.05		

Source: Own edition

The reason behind the decrease in the demand for diesel fuel is the introduction of biogas fuelled buses. The public transportation in the business as usual system is 100% dependent on diesel fuel, while the energy strategy's dependency is only 95.3%, a small but important step towards the set goals.

Figure 36 and Table 37 show the total change in the local versus external sources needed for the two different strategies. The 1 349 TJ decrease in the demand for external sources is offset by a 1 982 TJ increase for local energy sources. The reason behind the major difference between the absolute values is the introduction of the biogas plant which has an efficiency of 8%. Although this is a very low efficiency rate, the inputs (municipal and agricultural waste) are locally produced and can be made readily available. It can be concluded that the implementation of the energy strategy model decreases the demand for external source energy by 25.25%.

Figure 36: Comparison of fuel consumption of business as usual and energy strategy models

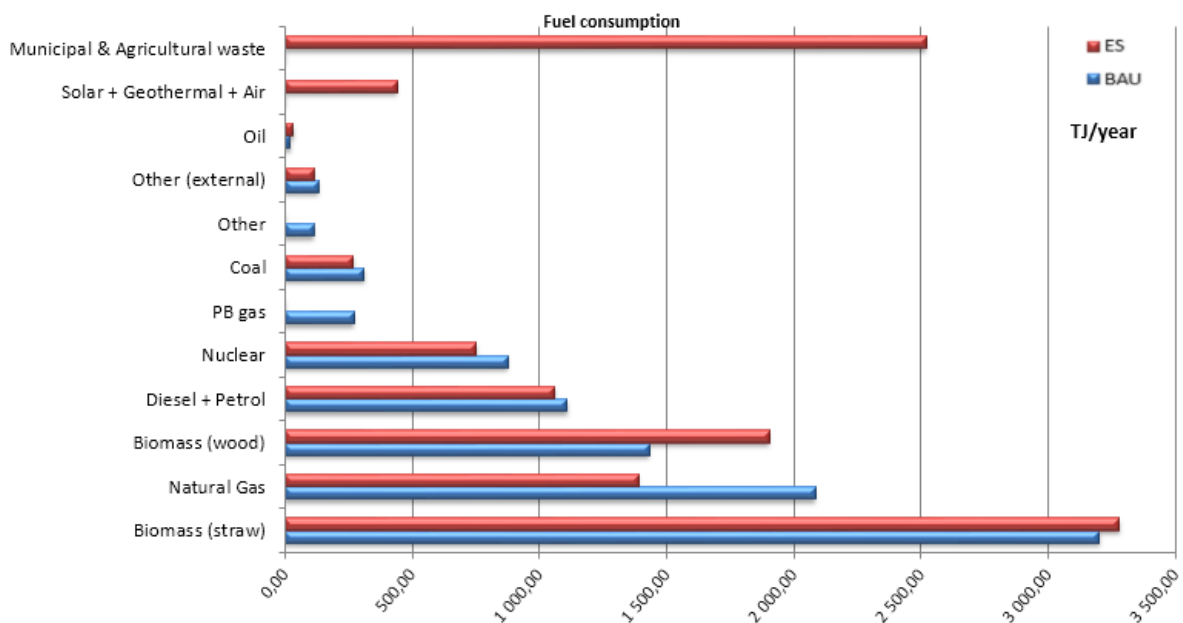

Source: Own edition

Table 37: Local vs. external sources of energy adjusted for consumption

TJ	Local	External
Business as usual	2 379	2 467
Energy strategy	3 121	1 617
Difference (TJ)	742	-850
Difference (%)	31.2%	-34.4%

Source: Own edition

The second aspect of comparison is the difference in share of energy from renewable sources in the final consumption. Table 36 summarizes the findings. The classification of natural gas, oil, coal, nuclear, diesel and petrol fuel is non-renewable, since they do not naturally replenish within a time span of a few years (definition based on Lund: Renewable

Energy Systems (2010)). Geothermal heat (used for district heating), heat from air (used by air based heat pumps), solar energy (photovoltaic cells + solar collectors), biogas and biomass are considered to be renewable.

Table 38: Comparison of consumption adjusted fuel use

	TJ	BAU	ES
Natural gas		1 399.9	852.4
Oil		11.1	19.7
Coal		128.8	112.2
Nuclear		363.1	315.5
Diesel + Petrol		333.0	317.7
PB gas		230.9	0.0
Biogas		0.0	142.5
Biomass (wood)		570.8	771.1
Biomass (straw)		1 673.9	1 714.7
Other		134.4	47.6
Geothermal		0.0	101.0
Air		0.0	265.0
Solar		0.0	79.0
Total		4 845.9	4 738.3

Source: Own edition

Figure 37: Comparison of share of energy from renewable sources in the final consumption

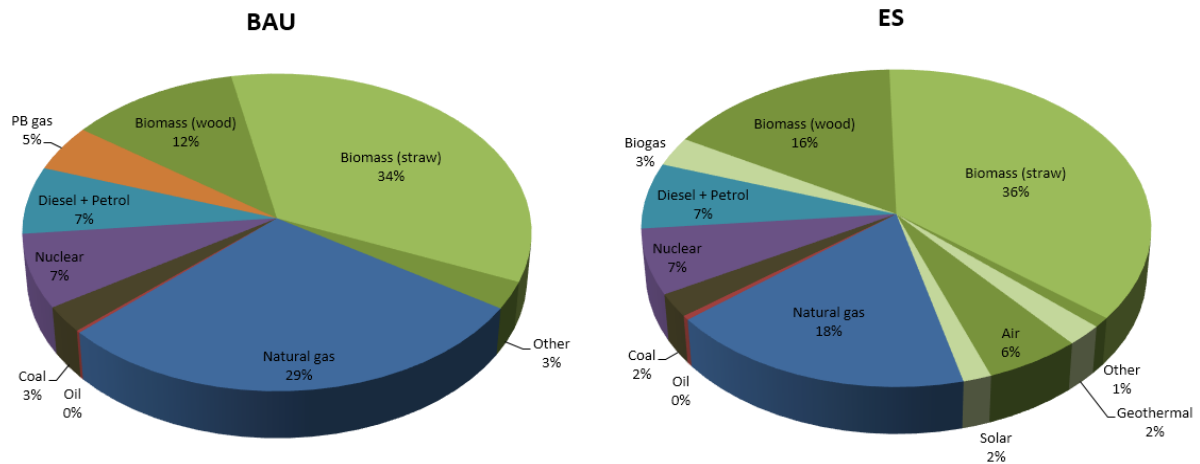

Source: Own edition

The values within the columns of Table 38 represent an energy demand that is adjusted to the proportion of the end use. The initial state of the share of renewable energy in the final consumption is a relatively high one, since due to the biomass fired CHP units the RE share is already 43.3%. The implementation of the energy strategy increases the share to 63.5%.

The following chapter will summarize the findings and the results of the experimental designs and evaluate them in light of the hypotheses.

Chapter 8 - Results

Chapter 8 summarizes the findings and results discussed in Chapter 7. It evaluates the output of the model with special emphasis on the discussion of the hypothesis of the dissertation. Comparison of the aggregated fuel use and the complex efficiency of the system serve as the main points of comparison for the two scenarios, which help the researcher to evaluate the hypotheses of the dissertation. The detailed flow diagrams help to visualize the difference of the two scenarios.

Steps X. – XII. More runs and Documentation and reporting

Steps of Simulation (a.)	
I.	Problem formulation
II.	Setting of objectives and overall project plan
III.	Model conceptualization
IV.	Data collection
V.	Model translation
VI.	Verified?
VII.	Validated?
VIII.	Experimental design
IX.	Production runs and analysis
X.	More runs?
XI.	Documentation and reporting
XII.	Implementation

H1: It is possible to design model of Pécs which incorporates the three basic areas of energy (electricity, heat and transportation) and is capable of simulating real life events.

The literature review lists the main, state of the art modelling of energy systems published in the leading journals of the area. In order to use these models to forecast the possible outcomes of energy scenarios, a model is developed and validated beforehand in order to assure that it works as intended and is suitable for further analysis. The validation process done by comparing values obtained from the simulation runs of the model with actual, real life values. These values typically include aggregated demands for the analysed sectors (heat, electricity, transportation), aggregated amount of generated energy by

conversion units and aggregated fuel use of the system. The deviation of the model values from actual values are determined in absolute and percentage terms. Although there is no widely accepted threshold under which a modelled value can be accepted, the deviation of modelled values generally stay under 2%, with one or two rare exceptions.

The model for the energy system of Pécs was developed for 3 years, with detailed analysis of both the demand and the supply side. The graphical layout of the model can be found in Figure 38 through 40. The energy conversion units producing the needed energy are in the middle section of Figure 38, whilst the inputs fuelling the conversion units are on the left hand side.

Figure 38: Graphical layout, district heating and electricity system

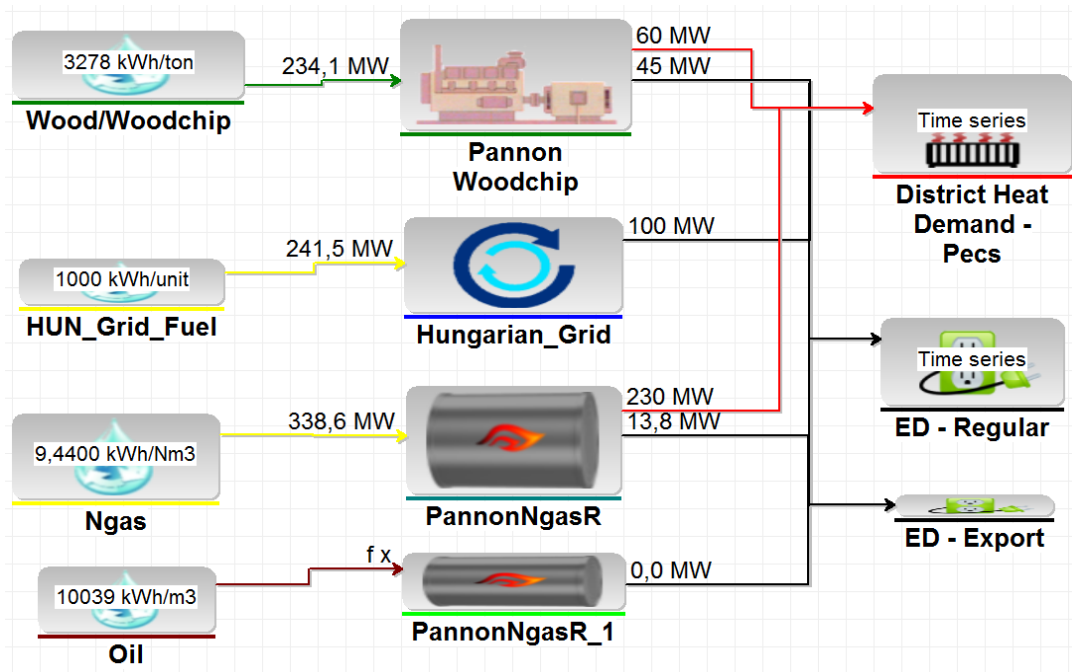

Source: Own edition

Figure 39: Graphical layout, individual heating systems

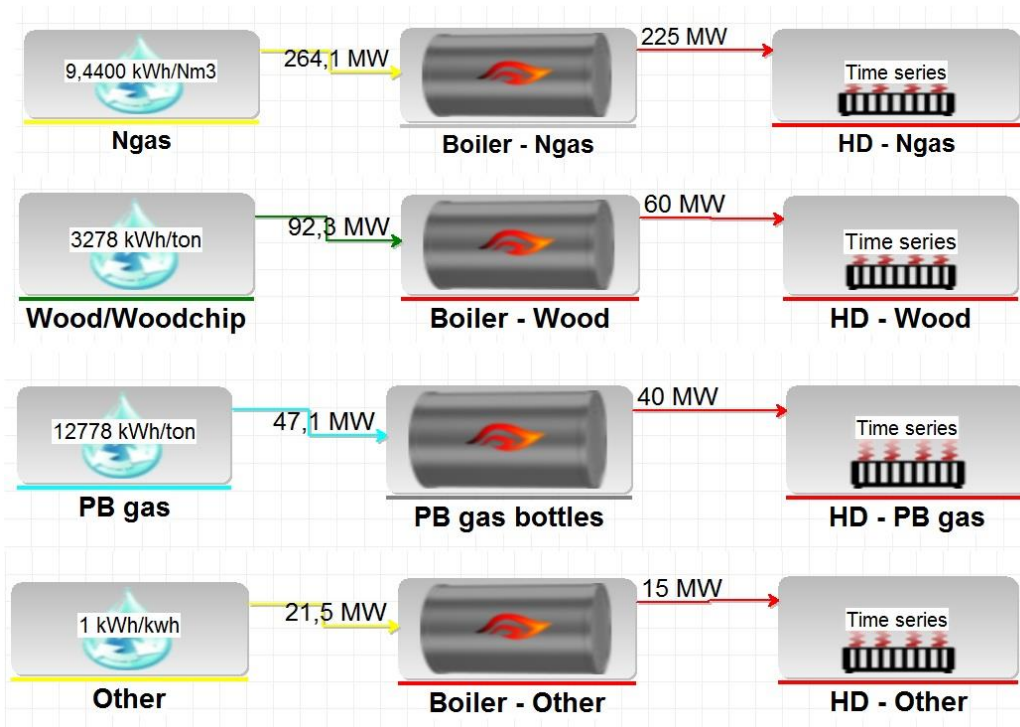

Source: Own edition

Figure 40: Graphical layout, transportation system

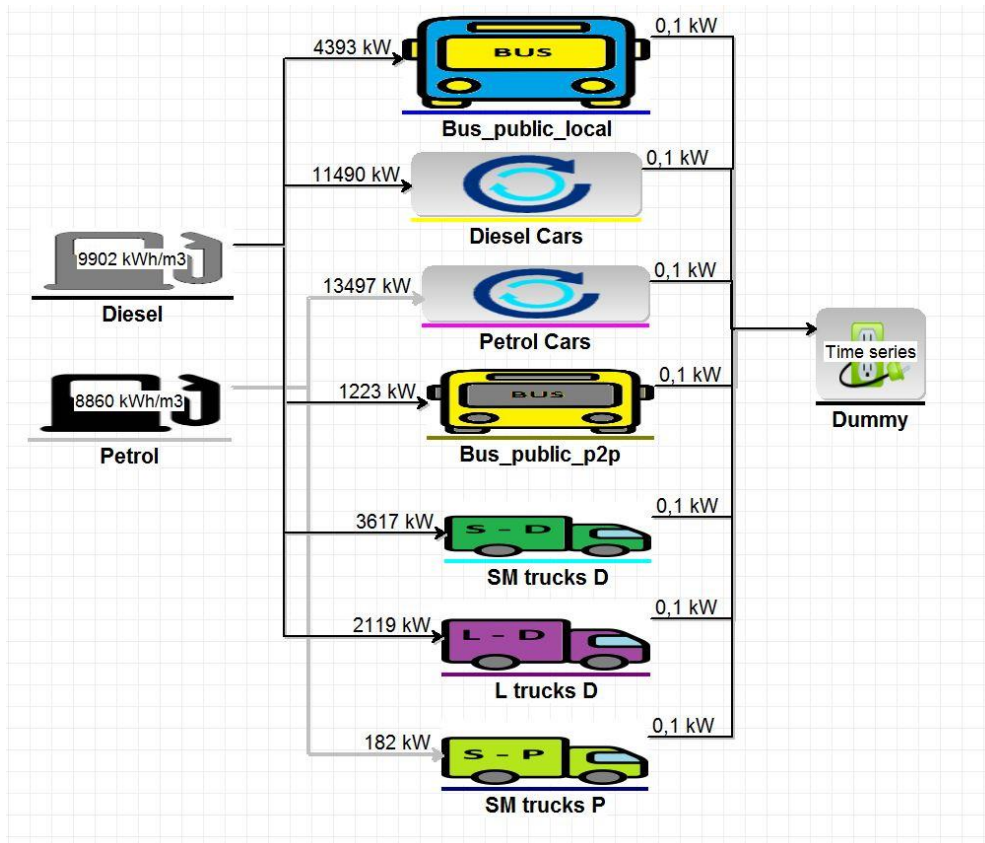

Source: Own edition

This model was then used for simulating the year 2012 from which year actual data was available, thus the developed simulation model could be validated. The validation of the reference model was made by comparing the aggregated values within the system for the modelled and the actual data. The results of the comparison can be found in Table 39.

Table 39: Validation of the 2012 Reference model

	Actual	Modelled	Diff. Unit	Diff. %
District heat demand (TJ)	1 488	1 497	9.0	0.6077
Peak district heat demand (MW)	191	188	2.9	-1.5183
Heat production of CHP unit (biomass) (TJ)	1 068	1 052	-17.2	-1.6133
Heat production of CHP unit (natural gas) (TJ)	420	422	2.4	0.5623
Natural gas demand (Individual heating systems) (TJ)	1 316	1 321	4.8	0.3635
PB demand (Individual heating systems) (TJ)	300	302	2.1	0.6848
Wood demand (Individual heating systems) (TJ)	105	106	0.6	0.5854
Other demand (Individual heating systems) (TJ)	126	127	1.2	0.9689
Electricity demand (TJ)	1 620	1 625	4.9	0.3048
Electricity production of CHP unit (biomass) (TJ)	N/A	789	N/A	N/A
Electricity production of CHP unit (natural gas) (TJ)	25.2	25.3	0.1	0.5629
Fuel use of vehicles (petrol) (TJ)	432	433	0.5	0.1233
Fuel use of vehicles (diesel) (TJ)	724	722	-1.6	-0.2216

Source: Own edition

The results obtained from the simulation of the reference model are very close to the actual values, the differences being invariably below 2% (mostly below 1%). The results clearly confirm that the developed model represents the energy system very closely and that it is, in consequence, satisfactory to conduct simulations for future energy systems. Therefore H1 is accepted.

H2: The implementation of the proposed energy strategy of Pécs would increase the energy security of the city.

Energy security is evaluated by the proportion of renewable sources in the system and the proportion of local versus external resources in the system.

Table 40 shows the fuel demand for both the BAU and the ES models. In the ES model natural gas was primarily replaced by renewable energy sources. This was due to the larger district heating system, the introduction of the biogas plant and to the fact that the alternative heating solutions targeted individual buildings formerly heated by natural gas. The Energy Strategy model has a 14.14% lower import of electricity, indirectly reducing the use of coal and nuclear energy. The total efficiency of the system is lower in the ES model, due to the introduction of the biogas plant, which uses a vast amount of biomass for its production

and has a low efficiency rate of conversion. Since, according to the Energy Strategy, the input for the biogas plant should comprise materials otherwise considered as waste (municipal and agricultural) this is not a major concern.

Table 40: Fuel input for BAU and ES models (TJ)

TJ	Business as usual	Energy strategy	Difference TJ	Difference %	Source	RES
Biomass (straw)	3 201.1	3 279.0	77.9	2.43	Local	Yes
Natural Gas	2 084.4	1 390.9	-693.5	-33.27	External	No
Biomass (wood)	1 432.6	1 902.9	470.3	32.83	Local	Yes
Diesel + Petrol	1 108.9	1 058.8	-50.2	-4.52	External	No
Nuclear	877.1	753.1	-124.0	-14.14	External	No
PB gas	271.8	0.0	-271.8	N/A	External	No
Coal	311.5	267.4	-44.0	-14.14	External	No
Other	114.5	0.0	-114.5	N/A	Local	Yes
Other (external)	131.1	112.6	-18.5	-14.14	External	Yes
Oil	20.5	31.3	10.9	53.00	External	No
Solar + Geothermal + Air	0.0	439.0	439.0	N/A	Local	Yes
Municipal & Agricultural waste	0.0	2 520.3	2 520.3	N/A	Local	Yes
Total	95 53.6	11 755.4	2 201.8	23.05		

Source: Own edition

For further comparison, the total demand for fuel is adjusted for consumption in Table 41. The proportion of renewable energy in final consumption is notably larger in the ES model (65.9% as opposed to 49.1%, Figure 41) - an important indicator in terms of sustainability and energy security.

Table 41: Fuel use, adjusted for consumption

TJ	BAU	ES
Natural gas	1 399.9	852.4
Oil	11.1	19.7
Coal	128.8	112.2
Nuclear	363.1	315.5
Diesel + Petrol	333.0	317.7
PB gas	230.9	0.0
Biogas	0.0	142.5
Biomass (wood)	570.8	771.1
Biomass (straw)	1 673.9	1 714.7
Other	134.4	47.6
Geothermal	0.0	101.0
Air	0.0	265.0
Solar	0.0	79.0
Total	4 845.9	4 738.3

Source: Own edition

Figure 41: Comparison of renewable energy as proportion of final consumption

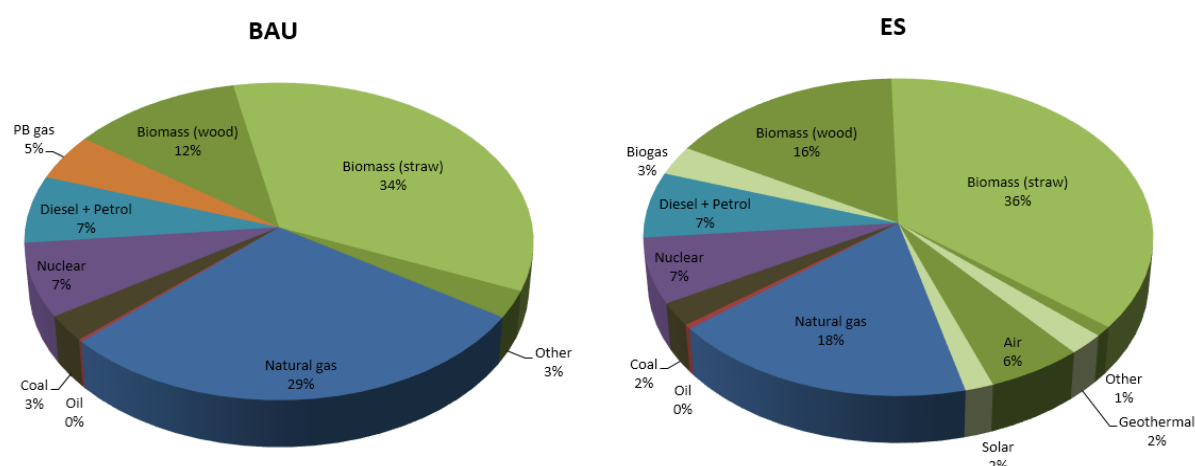

Source: Own edition

Table 40 shows all externally sourced fuel usage as smaller in the ES model, except for a minor increase in the demand for oil. Table 42 shows the aggregated change in the ‘local vs. external’ sources needed for the two different strategies.

Table 42: Local vs. external sources of energy, adjusted for consumption

TJ	Local	External
Business as usual	2 379	2 467
Energy strategy	3 121	1 617
Difference (TJ)	742	-850
Difference (%)	31.2%	-34.4%

We can see that implementing the Energy Strategy model produces a 34.4% lower demand for externally sourced energy. Since the local fuels are all renewable, whilst externally sourced energy mainly comprises fossil fuels (natural gas, nuclear energy, petroleum and coal) originating outside the country, the ES not only decreases its own energy dependence, but contributes to the energy independence of Hungary.

The results show that implementing the Energy Strategy would be advantageous in terms of energy security due to the higher proportion of renewable sources used and the higher proportion of local energy sources. Therefore H2 is accepted.

H3: The implementation of the proposed energy strategy of Pécs would increase the efficiency of the energy supply for the city.

An energy system is considered more efficient if it can deliver the same amount of energy from a smaller amount of resources. The analysis of the simulation showed us that the Business as Usual model delivers 4.840 TJ, while the Energy Strategy model delivers 4.742 TJ of useful energy to the city, while exporting 85 and 111 TJ of electricity respectively.

When analysing the efficiency rate of the two supply networks (Table 40), it is evident that the Energy Strategy models uses much a fuel mix which has 23% more energy content than the fuel mix of the Business as Usual system. This results in an efficiency rate, which is more than 10% smaller for the proposed energy system. The hypothesis initially has to be rejected, but it is important to note that the main reason for the difference is solely the new biogas plant which operates at a very low efficiency (9.3%), and the agricultural waste used for the plant would not have been used otherwise (without the implementation of the energy strategy). Please refer to Table 43 and the two Sankey diagrams for results (Figures 42 and 43).

Table 43: Efficiency of BAU and ES models

TJ	Aggregated Input	Output				Efficiency
		Export	Energy demand	Rejected energy		
Business as Usual	9 553,6	85,0	4 840,0	4 630,3	Business as Usual	51,6%
Energy Strategy	11 755,4	111,0	4 742,0	6 890,0	Energy Strategy	41,3%

Source: Own edition

Figure 42: Flow diagram of the BAU model²⁶

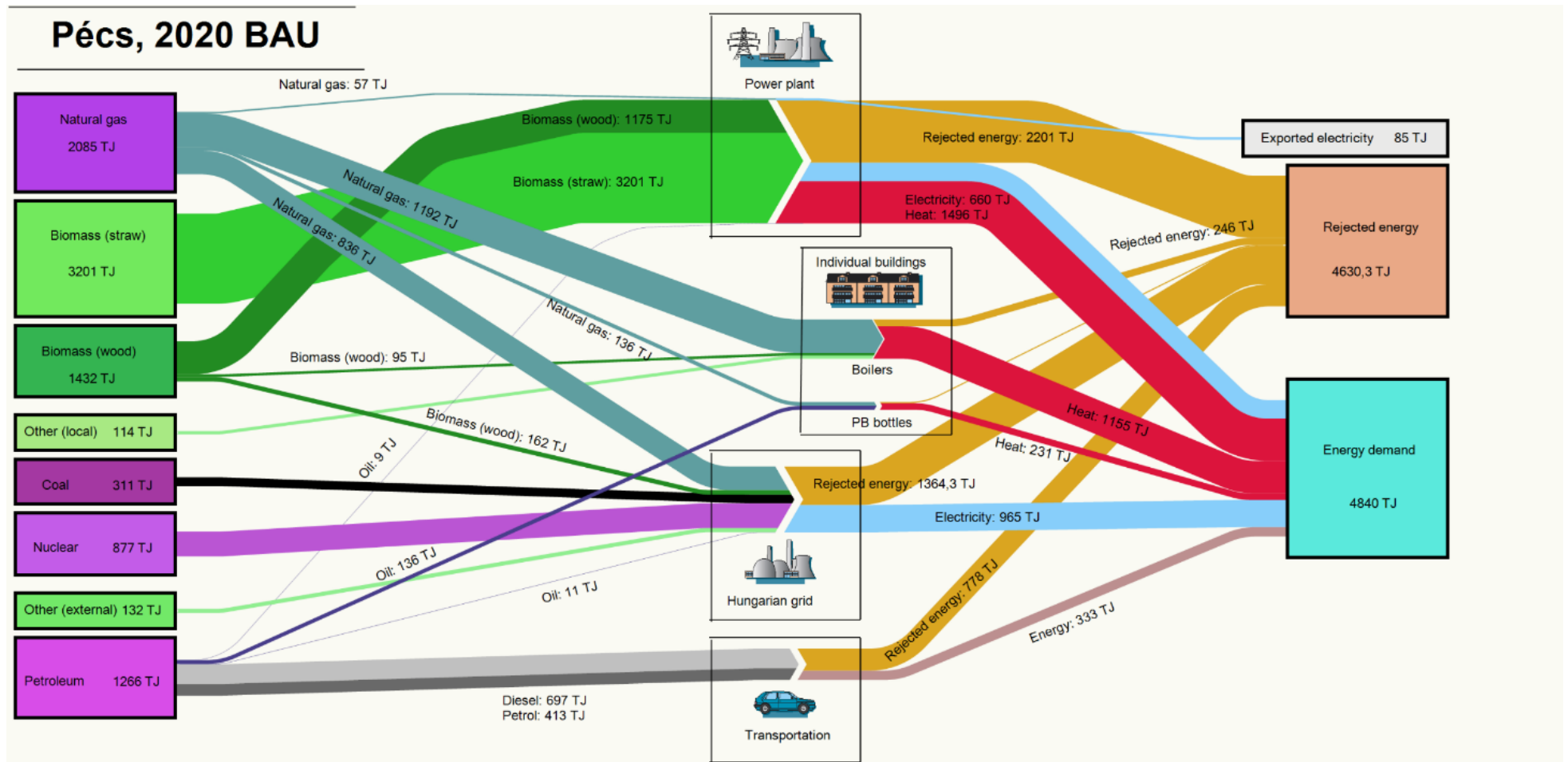

²⁶ The shades of purple indicate a non-renewable and of green a renewable energy source
The values might differ (+/- 0.5%) from Table 2 and Table 3 due to rounding

Figure 43: Flow diagram of the ES model²⁷

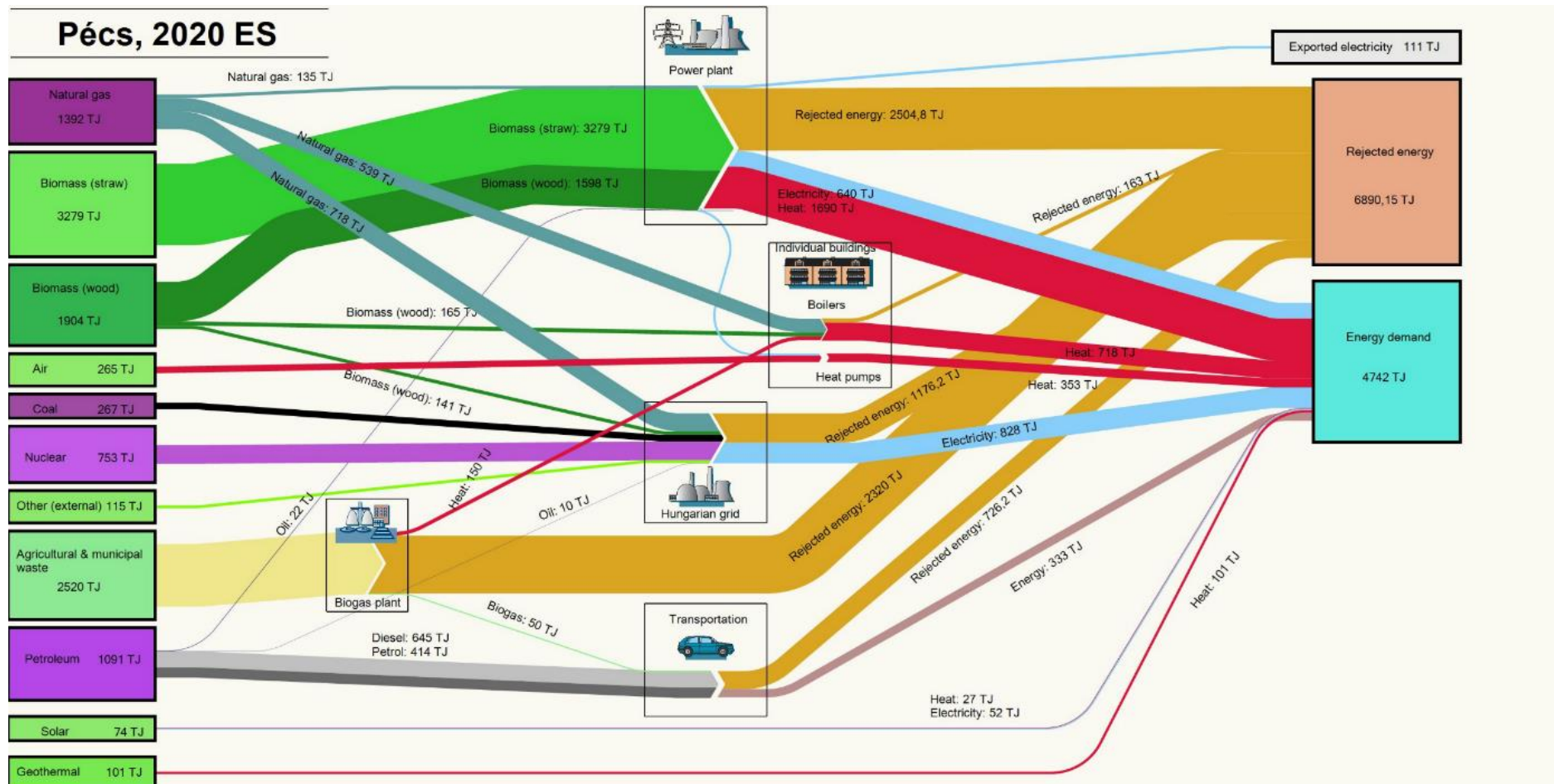

²⁷The shades of purple indicate a non-renewable and of green a renewable energy source
The values might differ (+/- 0.5%) from Table 2 and Table 3 due to rounding

The two flow charts show the two different states of the energy system of the city. Most of the changes proposed by the energy strategy can be tracked by comparing the two figures. The biogas plant and its output are used for both the transportation and the individual heating systems.

An alternative approach

The calculation of efficiency is the ratio of useful outputs to energy inputs (Lovins, 1977; Ming and Xin, 2015). Ideally all the energy conversion units which use biodegradable material (biogas plant and the biomass burning CHP units of the power plant) source their inputs using only materials that would otherwise be waste, and not used. So it would be reasonable to argue, that the poor energy conversion efficiency of the units using biomass should not be included in the calculations of the total energy efficiency of the system. Any useful energy that can be withdrawn from otherwise wasted material should not decrease the efficiency of the energy system. If all biomass related energy conversion are thought of as 100% energy efficient different result emerge. With this in mind, the calculation of the energy efficiency is redone and evaluated with the help of the following table:

Table 44: Efficiency of BAU and ES models, II.

TJ	Aggregated Input	Export	Output		Efficiency
			Energy Demand	Rejected Energy	
Business as Usual	7 164.5	85.0	4 840.0	2 239.5	68.7%
Energy Startegy	6 687.4	111.0	4 742.0	1 834.4	72.6%

It can be stated that with this alternative approach, the total efficiency of the energy systems radically increase. The energy conversion systems of the Energy Strategy model are more efficient.

As a final conclusion H3 is partially rejected, since in the classical approach of energy efficiency calculation defined by Lovins (1977) and Ming and Xin (2015) the implementation of the energy strategy would result in a less efficient energy system than the Business as Usual system. However the inclusion of large plants which use material otherwise considered as waste has to be taken into consideration.

Conclusion and further research areas

The sharp rise in the global demand for energy has several consequences, of which some are of major importance. This demand is primarily supplied by fossil fuels, which are unevenly distributed around the globe and their combustion negatively affects the climate change. It is the unanimous opinion of researchers that dramatic changes need to be made in our energy supply chain if we are to overcome the mounting negative effects.

Local energy management has the potential of initiating and contributing to this change. In 2013, Pécs has issued an energy strategy which intends to put the energy system of the city on a more sustainable, energy secure and energy efficient path. In order for the decision makers to be able to make an informed decision, a simulation model was developed which is capable of analysing the proposed changes in the energy strategy and examine the potential positive and negative effects. This decision making system can serve the city of Pécs by being able to simulate a wide number of potential changes in the energy system and being able to analyse its effects.

The results of the research have shown that by implementing the proposed changes of the energy strategy, the city of Pécs would indeed be more secure in terms of energy supply, would use more renewable sources, but would not be more energy efficient in the strictest sense of the term.

The performed analysis of the research used the uniquely developed and validated model for the energy system of Pécs. This model capable of accommodating practically any realistic change within the energy system and evaluating its effects, creating a wide variety of further research areas, where any realistic idea can be simulated. Specifically planned future research areas are the introduction of a large volume of electric cars and the installation of a collection of PV panels which would supply a large proportion of the city's electricity demand.

References

- AIAA Guide: Guide for the Verification and Validation of Computational Fluid Dynamics Simulations*. Reston, VA: American Institute of Aeronautics and Astronautics, 1998.
- Analysis - Hungarian Electricity Sector - Stróbl, Alajos, Dr. "A Magyar Villamosenergia-ellátás Előző évi Változásainak Elemzése, Különös Tekintettel a Kapacitások Változására." *MAVIR – PÖYRY-ERŐTERV Szerződéses Munka* (2012): n. pag. Web.
- Antoine, B., K. Goran, and D. Neven. "Energy Scenarios for Malta☆." *International Journal of Hydrogen Energy* 33.16 (2008): 4235-246.
- Banks, Jerry and R.R. Gibson. Don't simulate When: 10 Rules for Determining when Simulation Is Not Appropriate. IIE Solutions, September 1997. Print.
- Banks, Jerry. *Handbook of Simulation: Principles, Methodology, Advances, Applications, and Practice*. New York: Wiley, 1998
- Banks, Jerry, John S. Carson, Barry L. Nelson, and David M. Nicol. *Discrete-event System Simulation*. N.p.: Prentice-Hall, 2009. Print.
- Banks, Jerry, John S. Carson, Barry L. Nelson, and David M. Nicol. *Discrete-event System Simulation*. N.p.: Prentice-Hall, Fifth edition. 2014. Print.
- Beeck, N. Van. *Classification of Energy Models*. Tilburg: Tilburg University, Faculty of Economics and Business Administration, 1999.
- Biomass Sustainability and Carbon Policy Study*. Brunswick, Me.: Manomet Center for Conservation Sciences, 2010.
- Bjelić, Ilija Batas, Nikola Rajaković, Boris Ćosić, and Neven Duić. "Increasing Wind Power Penetration into the Existing Serbian Energy System." *Energy* 57 (2013): 30-37.
- Blarke, Morten B., and Erik Dotzauer. "Intermittency-friendly and High-efficiency Cogeneration: Operational Optimisation of Cogeneration with Compression Heat Pump, Flue Gas Heat Recovery, and Intermediate Cold Storage." *Energy* 36.12 (2011): 6867-878.
- Börjesson, Pål, and Leif Gustavsson. "Greenhouse Gas Balances in Building Construction: Wood versus Concrete from Life-cycle and Forest Land-use Perspectives." *Energy Policy* 28.9 (2000): 575-88.
- Bossel, Hartmut. *Modeling and Simulation*. Wellesley, MA: A.K. Peters, 1994. Print.
- BP Statistical Review of World Energy*. London: BP Plc, 2013. Print.
- BP Statistical Review of World Energy*. London: BP Plc, 2014. Print.
- BP Statistical Review of World Energy*. London: BP Plc, 2015. Print.
- Bracmort, Kelsi. „Is Biopower Carbon Neutral?” Congressional Research Service, CRS Report for Congress, 7-5700 www.crs.gov R41603, 2013
- Budzianowski, Wojciech M. "Target for National Carbon Intensity of Energy by 2050: A Case Study of Poland's Energy System." *Energy* 46.1 (2012): 575-81.

- Cao, Yucheng, and Shengdao Shan. "Sustainable Approach to Energy Recovery from Sewage Sludge." *2011 2nd International Conference on Environmental Engineering and Applications IPCBEE 17* (2011): n. pag. Web
- "Carbon Emissions of Different Fuels." N.p., n.d. Web. 21 Feb. 2014.
http://www.biomassenergycentre.org.uk/portal/page?_pageid=75,163182&_dad=portal1&_schema=PORTAL [accessed: 2014.01.17.]
- "Carbon Neutral" – Def. Oxford Advanced Learner's Dictionary Web. 21 Feb. 2014
- Catenazzi, Giacomo. *Advances in Techno-economic Energy Modelling: Costs, Dynamics and Hybrid Aspects*. Zürich: ETH, 2009.
- Choi, Byoung Kyu, and Donghun Kang. *Modeling and Simulation of Discrete-event Systems*. N.p.: n.p., n.d. 2013 Print
- The Climate Registry's 2013 Default Emission Factors*. Rep. The Climate Registry, 2 Jan. 2013. Web. 18 Jan. 2013.
<http://www.theclimateregistry.org/downloads/2013/01/2013-Climate-Registry-Default-Emissions-Factors.pdf> [accessed: 2014.01.17.]
- Connolly, D., H. Lund, B.v. Mathiesen, and M. Leahy. "A Review of Computer Tools for Analysing the Integration of Renewable Energy into Various Energy Systems." *Applied Energy* 87.4 (2010): 1059-082.
- Connolly, D., H. Lund, B.v. Mathiesen, and M. Leahy. "Modelling the Existing Irish Energy-system to Identify Future Energy Costs and the Maximum Wind Penetration Feasible." *Energy* 35.5 (2010): 2164-173.
- Connolly, D., H. Lund, B.v. Mathiesen, and M. Leahy. "The First Step towards a 100% Renewable Energy-system for Ireland." *Applied Energy* 88.2 (2011): 502-07.
- Connolly, D., H. Lund, B.v. Mathiesen, S. Werner, B. Möller, U. Persson, T. Boermans, D. Trier, P.a. Østergaard, and S. Nielsen. "Heat Roadmap Europe: Combining District Heating with Heat Savings to Decarbonise the EU Energy System." *Energy Policy* 65 (2014): 475-89
- CO2 and Other Environmental Emissions Data." *Sustainable Energy Authority of Ireland*(n.d.): n. pag. Web. http://www.seai.ie/Archive1/Files_Misc/emissionsdata.pdf [accessed: 2014.01.13.]
- "CO2 Emissions from Fuel Combustion 2012 - Highlights (Pre-Release)." *IEA*. N.p., n.d. Web. 24 Feb. 2014.
- Ćosić, Boris, Goran Krajačić, and Neven Duić. "A 100% Renewable Energy System in the Year 2050: The Case of Macedonia." *Energy* 48.1 (2012): 80-87.
- CTA. Center for Transportation analysis. "Lower and Higher Heating Values of Gas, Liquid and Solid Fuels"
http://cta.ornl.gov/bedb/appendix_a/Lower_and_Higher_Heating_Values_of_Gas_Liquid_and_Solid_Fuels.pdf 2013 [accessed: 2014.01.11.]
- Demiroren, A., and U. Yilmaz. "Analysis of Change in Electric Energy Cost with Using Renewable Energy Sources in Gökceada, Turkey: An Island Example." *Renewable and Sustainable Energy Reviews* 14.1 (2010): 323-33.
- Downie, Adriana, David Lau, Annette Cowie, and Paul Munroe. "Approaches to Greenhouse Gas Accounting Methods for Biomass Carbon." *Biomass and Bioenergy* (2013): n. pag.

- Duić, Neven, and Maria Da Graça Carvalho. "Increasing Renewable Energy Sources in Island Energy Supply: Case Study Porto Santo." *Renewable and Sustainable Energy Reviews* 8.4 (2004): 383-99.
- Duquette, Jean, Peter Wild, and Andrew Rowe. "The Potential Benefits of Widespread Combined Heat and Power Based District Energy Networks in the Province of Ontario." *Energy* (2014)
- Ecofys.com. World GHG Emissions Flow Chart, <http://www.ecofys.com/files/files/asn-ecofys-2013-world-ghg-emissions-flow-chart-2010.pdf> 2010 [accessed: 2014.01.11.]
- Elliston, Ben, Mark Diesendorf, and Iain Macgill. "Simulations of Scenarios with 100% Renewable Electricity in the Australian National Electricity Market." *Energy Policy* 45 (2012): 606-13
- Elliston, Ben, Iain Macgill, and Mark Diesendorf. "Least Cost 100% Renewable Electricity Scenarios in the Australian National Electricity Market." *Energy Policy* 59 (2013): 270-82
- Elliston, Ben, Iain Macgill, and Mark Diesendorf. "Comparing Least Cost Scenarios for 100% Renewable Electricity with Low Emission Fossil Fuel Scenarios in the Australian National Electricity Market." *Renewable Energy* 66 (2014): 196-204
- "EMD - EnergyPRO." *EMD*. N.p., n.d. Web. 20 Jan. 2014.
- Energy Strategy of Pécs, 2013 Original title: Pécs Megyei Jogú Város Energiestratégiája - *Kék Gazdaság Konzorcium* (Blue Economy Syndicate) (2013): Print
- Environmental impact study of boiler NO.3 - Development of the biomass based CHP, (Original title: A 3. Számú kazán létesítésének környezeti hatástanulmányam a Pannon-Hő Kft. biomassza tüzelésű fejlesztése) Pannon-HŐ Kft Work number: T-2006-16-KHV
- Emission Factors for GHG Inventories – United States Environmental Protection Agency <http://www.epa.gov/climateleadership/documents/emission-factors.pdf> Web. 20 Jan. 2014 [accessed: 2013.02.11.]
- Esteban, Miguel, Qi Zhang, and Agya Utama. "Estimation of the Energy Storage Requirement of a Future 100% Renewable Energy System in Japan." *Energy Policy* 47 (2012): 22-31.
- Fernandes, Liliana and Paula Ferreira. "Renewable energy scenarios in the Portuguese electricity system." *Energy*, In Press, Corrected Proof (2014)
- Forrester, J. W. and P. Senge. "Tests for building confidence in system dynamics models", in Legasto, A., J. W. Forrester, and J. Lyneis (eds.) *System Dynamics. TIMS Studies in the Management Sciences* 14. New York North-Holland, (1980): 209-228
- Fragaki, Aikaterini, Anders N. Andersen, and David Toke. "Exploration of Economical Sizing of Gas Engine and Thermal Store for Combined Heat and Power Plants in the UK." *Energy* 33.11 (2008): 1659-670.
- Fragaki, Aikaterini, and Anders N. Andersen. "Conditions for Aggregation of CHP Plants in the UK Electricity Market and Exploration of Plant Size." *Applied Energy* 88.11 (2011): 3930-940.
- "Fuel Emission Factors." *Appendix H of the Instructions to Form EIA-1605* (n.d.): n. pag. *US Energy Information Administration*. Web. http://www.eia.gov/oiaf/1605/emission_factors.html [accessed: 2014.01.11.]

- Gebremedhin, Alemayehu. "Optimal Utilisation of Heat Demand in District Heating System—A Case Study." *Renewable and Sustainable Energy Reviews* 30 (2014): 230-36.
- Ghazali, Najoua, Shamira Abbasi Nejad, and Banoit Vargnaud. "Biogas Bus Use and Operational Experiences." *A Project to Stimulate the Use of Biogas as Fuel for City Buses* (2012): n. pag. Web. <http://www.balticbiogasbus.eu/web/Upload/Use_of_biogas/Act_6_2/Biogas%20bus%20use%20and%20operational%20experiences.pdf>. [accessed: 2014.02.07.]
- "Global Irradiation and Solar Electricity Potential." European Commission, n.d. Web. 14 Jan. 2014. http://re.jrc.ec.europa.eu/pvgis/cmmaps/eu_cmsaf_opt/G_opt_HU.pdf [accessed: 2014.04.01.]
- Glossary, Climate change – United States Environmental Agency Web. 20 Jan. 2014. <http://www.epa.gov/climatechange/glossary> [accessed: 2014.01.02.]
- Gota, Dan-Ioan, Henrik Lund, and Liviu Miclea. "A Romanian Energy System Model and a Nuclear Reduction Strategy." *Energy* 36.11 (2011): 6413-419.
- The Greenhouse Gas Protocol: A Corporate Accounting and Reporting Standard*. Geneva, Switzerland: World Business Council for Sustainable Development, 2004.
- Hajdú, József, Dr. "The Operation and Technology of Biogas Plants - Biogázüzemek Működése és Biogáz üzemi Technológiák." *OBEKK Tudományos Szakmai Kiadványok Sorozat* 11/12 (2009): n. pag. ISBN 978-963-269-157-2. Web. <http://medgyesegyhaza.hu/adat/htmlfiles/Biog%C3%A1z%20tech%20le%C3%ADr%C3%A1s.pdf> [accessed: 2014.02.11.]
- Hedegaard, Karsten, Brian Vad Mathiesen, Henrik Lund, and Per Heiselberg. "Wind Power Integration Using Individual Heat Pumps – Analysis of Different Heat Storage Options." *Energy* 47.1 (2012): 284-93.
- Herbst, Andrea, Felipe Andrés Toro, Felix Reitze, and Eberhard Jochem. "Introduction to Energy Systems Modelling." *Swiss Journal of Economics and Statistics* 148.II. June (2012): 111+. Web. <http://www.sjes.ch/papers/2012-II-2.pdf> [accessed: 2014.07.01.]
- Hiendro, Ayong, Rudi Kurnianto, Managam Rajagukguk, Yohannes M. Simanjuntak, and Junaidi. "Techno-economic Analysis of Photovoltaic/wind Hybrid System for Onshore/remote Area in Indonesia." *Energy* 59 (2013): 652-57
- Hong, Lixuan, Henrik Lund, and Bernd Möller. "The Importance of Flexible Power Plant Operation for Jiangsu's Wind Integration." *Energy* 41.1 (2012): 499-507.
- Hong, Lixuan, Henrik Lund, Brian Vad Mathiesen, and Bernd Möller. "2050 Pathway to an Active Renewable Energy Scenario for Jiangsu Province." *Energy Policy* 53 (2013): 267-78.
- Hungarian vehicle emissions – Presentation, Budapest University of Technology and Economics Web. 20 Nov. 2013. <http://www.uvt.bme.hu/targyak/uttermv/uttermv_fi_ea/24.pdf> [accessed: 2014.01.23.]
- IEA. "CO2 Emissions from Fuel Combustion, IEA Statistics" International Energy Agency HIGHLIGHTS. Paris, France (2014)
- IPCC, Annex II. – Glossary of Working groups of I, II and III to the IPCC Fourth Assessment Report. Intergovernmental Panel on Climate Change <http://www.ipcc.ch>

- IPCC Guideline: Gómez, Darío R., and John D. Watterson. "Stationary Combustion." *IPCC Guidelines for National Greenhouse Gas Inventories* Chapter 2. (2006): Web. <http://www.ipcc-nggip.iges.or.jp/public/2006gl/vol2.html> [accessed: 2014.01.21.]
- Jacobs, Jeremy P., and Jean Chemnick. "E&E Publishing ." *CLIMATE: Court Rejects EPA Rule That Deferred Carbon Standards for Biomass Industry*. N.p., n.d. Web. 22 Feb. 2014.
- Johnson, Eric. "Goodbye to Carbon Neutral: Getting Biomass Footprints Right." *Environmental Impact Assessment Review* 29.3 (2009): 165-68.
- Kim, Heetae, Seoin Baek, Eunil Park, and Hyun Joon Chang. "Optimal Green Energy Management in Jeju, South Korea – On-grid and Off-grid Electrification." *Renewable Energy* 69 (2014): 123-33.
- Kim, Janghyun, Woojin Cho, and Kwan-Soo Lee. "Optimum Generation Capacities of Micro Combined Heat and Power Systems in Apartment Complexes with Varying Numbers of Apartment Units." *Energy* 35.12 (2010): 5121-131.
- Kleijnen, Jack P.c. "Verification and Validation of Simulation Models." *European Journal of Operational Research* 82.1 (1995): 145-62.
- Krajačić, Goran, Neven Duić, and Maria Da Graça Carvalho. "How to Achieve a 100% RES Electricity Supply for Portugal?" *Applied Energy* 88.2 (2011): 508-17.
- Krajačić, Goran, Neven Duić, Zlatko Zmijarević, Brian Vad Mathiesen, Aleksandra Anić Vučinić, and Maria Da Graça Carvalho. "Planning for a 100% Independent Energy System Based on Smart Energy Storage for Integration of Renewables and CO2 Emissions Reduction." *Applied Thermal Engineering* 31.13 (2011): 2073-083.
- Kwon, Pil Seok, and Poul Alberg Østergaard. "Comparison of Future Energy Scenarios for Denmark: IDA 2050, CEESA (Coherent Energy and Environmental System Analysis), and Climate Commission 2050." *Energy* 46.1 (2012): 275-82.
- Kwon, Pil Seok, and Poul Alberg Østergaard. "Priority Order in Using Biomass Resources – Energy Systems Analyses of Future Scenarios for Denmark." *Energy* (2013)
- Kyoto Protocol. – United Nations Framework Convention on Climate Change. Web. 20 Nov. 2013. <http://www.unfccc.int> [accessed: 2014.01.21.]
- Law, Averill M., and W. David Kelton. *Simulation Modeling and Analysis*. Third Edition, McGraw-Hill, 2000. Print.
- Le, Ngoc Anh, and Subhes C. Bhattacharyya. "Integration of Wind Power into the British System in 2020." *Energy* 36.10 (2011): 5975-983.
- Liu, Wen, Henrik Lund, and Brian Vad Mathiesen. "Large-scale Integration of Wind Power into the Existing Chinese Energy System." *Energy* 36.8 (2011): 4753-760.
- Lovins A. "The road not taken? Eenergy strategy: friends of the earth's not man apart." *Spec Reprint Issue* 6.20 (1977)
- Lund, H. "Large-scale Integration of Optimal Combinations of PV, Wind and Wave Power into the Electricity Supply." *Renewable Energy* 31.4 (2006): 503-15
- Lund, Henrik. "The Implementation of Renewable Energy Systems. Lessons Learned from the Danish Case." *Energy* 35.10 (2010): 4003-009.

- Lund, Henrik. *Renewable Energy Systems: The Choice and Modelling of 100% Renewable Solutions*. Burlington, MA: Academic, 2010.
- Lund, Henrik, Anders N. Andersen, Poul Alberg Østergaard, Brian Vad Mathiesen, and David Connolly. "From Electricity Smart Grids to Smart Energy Systems – A Market Operation Based Approach and Understanding." *Energy* 42.1 (2012): 96-102
- Lund, Henrik., and B.v. Mathiesen. "Energy System Analysis of 100% Renewable Energy Systems—The Case of Denmark in Years 2030 and 2050." *Energy* 34.5 (2009): 524-31.
- Lund, Henrik, Frede Hvelplund, Poul Alberg Østergaard, Bernd Möller, Brian Vad Mathiesen, Peter Karnøe, Anders N. Andersen, Poul Erik Morthorst, Kenneth Karlsson, Marie Münster, Jesper Munksgaard, and Henrik Wenzel. "System and Market Integration of Wind Power in Denmark." *Energy Strategy Reviews* 1.3 (2013): 143-56
- Lund, Henrik., G. Šiupšinskas, and V. Martinaitis. "Implementation Strategy for Small CHP-plants in a Competitive Market: The Case of Lithuania." *Applied Energy* 82.3 (2005): 214-27
- Lund, Henrik, Sven Werner, Robin Wiltshire, Svend Svendsen, Jan Eric Thorsen, Frede Hvelplund, and Brian Vad Mathiesen. "4th Generation District Heating (4GDH)." *Energy* (2014)
- Ma, Tao, Poul Alberg Østergaard, Henrik Lund, Hongxing Yang and Lin Liu. "An energy system model for Hong Kong." *Energy*, In Press, Corrected Proof (2014)
- Mason, I.g., S.c. Page, and A.g. Williamson. "A 100% Renewable Electricity Generation System for New Zealand Utilising Hydro, Wind, Geothermal and Biomass Resources." *Energy Policy* 38.8 (2010): 3973-984.
- Mathiesen, Brian Vad, Henrik Lund, and David Connolly. "Limiting Biomass Consumption for Heating in 100% Renewable Energy Systems." *Energy* 48.1 (2012): 160-68.
- Maria, A. "Introduction to modelling and simulation." *Proceedings of the 1997 Winter Simulation Conference*, (1997): 7-13.
- Matek, Benjamin. "Promoting Geothermal Energy: Air Emissions Comparison and Externality Analysis." *Geothermal Energy Association* April (2013): n. pag. Web. <http://geo-energy.org/events/Air%20Emissions%20Comparison%20and%20Externality%20Analysis_Publication.pdf>. [accessed: 2014.01.20.]
- Medić, Zlatko Bačelić, Boris Čosić, and Neven Duić. "Sustainability of Remote Communities: 100% Renewable Island of Hvar." *Journal of Renewable and Sustainable Energy* 5.4 (2013): 041806
- Ming, Y., Xin Yu. "Energy Efficiency : Benefits for Environment and Society." Springer-Verlag London (2015)
- Möller, Bernd, and Henrik Lund. "Conversion of Individual Natural Gas to District Heating: Geographical Studies of Supply Costs and Consequences for the Danish Energy System." *Applied Energy* 87.6 (2010): 1846-857.
- Münster, Marie, Poul Erik Morthorst, Helge V. Larsen, Lars Bregnbæk, Jesper Werling, Hans Henrik Lindboe, and Hans Ravn. "The Role of District Heating in the Future Danish Energy System." *Energy* 48.1 (2012): 47-55.

- Nielsen, Steffen, and Bernd Möller. "Excess Heat Production of Future Net Zero Energy Buildings within District Heating Areas in Denmark." *Energy* 48.1 (2012): 23-31.
- Østergaard, Poul Alberg, Brian Vad Mathiesen, Bernd Möller, and Henrik Lund. "A Renewable Energy Scenario for Aalborg Municipality Based on Low-temperature Geothermal Heat, Wind Power and Biomass." *Energy* 35.12 (2010): 4892-901
- Østergaard, Poul Alberg, and Henrik Lund. "A Renewable Energy System in Frederikshavn Using Low-temperature Geothermal Energy for District Heating." *Applied Energy* 88.2 (2011): 479-87
- Østergaard, Poul Alberg. "Comparing Electricity, Heat and Biogas Storages' Impacts on Renewable Energy Integration." *Energy* 37.1 (2012): 255-62.
- Østergaard, Poul Alberg. "Regulation Strategies of Cogeneration of Heat and Power (CHP) Plants and Electricity Transit in Denmark." *Energy* 35.5 (2010): 2194-202.
- Østergaard, Poul Alberg. "Wind Power Integration in Aalborg Municipality Using Compression Heat Pumps and Geothermal Absorption Heat Pumps." *Energy* 49 (2013): 502-08.
- Østergaard, Poul Alberg, H. Lund, F. Hvelplund, B. Möller, B. V. Mathiesen, A. Remmen - Energy vision for Aalborg municipality 2050 (original Danish title: Energivision for Aalborg Kommune 2050)
- Oxford Advanced Learner's Dictionary, Online version. <http://www.oxforddictionaries.com/> [accessed: 2013.12.12]
- Pannon-HŐ Kft. Environmental impact study of boiler NO.3 - Development of the biomass based CHP. [A 3. Számú kazán létesítésének környezeti hatástanulmányam a Pannon-Hő Kft. biomassza tüzelésű fejlesztése] Work number: T-2006-16-KHV. Pécs, Hungary. 2006.
- Pannonpower. - New biomass power plant officially launched in Pécs. <http://www.pannonpower.hu/en/member-companies/pannon-ho-kft/news/hir:211/new-biomass-power-plant-officially-launched-in-pecs>, 2013 [accessed: 2013.12.12]
- Pagliarini, Giorgio, and Sara Rainieri. "Modelling of a Thermal Energy Storage System Coupled with Combined Heat and Power Generation for the Heating Requirements of a University Campus." *Applied Thermal Engineering* 30.10 (2010): 1255-261.
- Pegden, C. D., Shannon, R. E., & Sadowski, R. P.. Introduction to simulation using SIMAN (2nd Ed.), Singapore: McGraw-Hill, 1995. Print.
- PÉTÁV. Production schedule of district heating system. Pécs, Hungary. 2012.
- Pettersson, Anneli, and Arthur Wellinger. "Biogas Upgrading Technologies - Developments and Innovations." *IEA Bioenergy Task 37* (2009): n. pag. [Http://www.en.esbjerg.aau.dk/digitalAssets/80/80449_iea-biogas-upgrading-report-2009.pdf](http://www.en.esbjerg.aau.dk/digitalAssets/80/80449_iea-biogas-upgrading-report-2009.pdf). Web. [accessed: 2014.02.08.]
- Poncelet, Jean-Pol. "Nuclear Power in the Future Energy Landscape." *Bulaton Conference*(2013): n. pag. Web. 12 Jan. 2014. <http://www.bulatom-bg.org/files/Referendum/presentations_site/Jean_Pol_Poncelet_presentation.pdf>. [accessed: 2014.01.11.]
- "Production Schedule, District Heating System, Pécs." *PÉTÁV, District Heating Company, Pécs* (2012): n. pag. Web.

- Production Schedule, District Heating System, Pécs." *PÉTÁV, District Heating Company, Pécs* (2013): n. pag. Web.
- Quaschnig, Volker. *Understanding Renewable Energy Systems*. London: Earthscan, 2005.
- Quaschnig, Volker. *Understanding Renewable Energy Systems*. London: Earthscan, 2010
- Rabl, Ari, Anthony Benoist, Dominique Dron, Bruno Peuportier, Joseph V. Spadaro, and Assaad Zoughaib. "How to Account for CO2 Emissions from Biomass in an LCA." *The International Journal of Life Cycle Assessment* 12.5 (2007): 281.
- Rohani, Golbarg, and Mutasim Nour. "Techno-economical Analysis of Stand-alone Hybrid Renewable Power System for Ras Musherib in United Arab Emirates." *Energy* (2013)
- Sáfian, Fanni. "Modelling the Hungarian energy system – The first step towards sustainable energy planning." *Energy*. In Press, Corrected Proof (2014)
- Segurado, Raquel, Goran Krajačić, Neven Duić, and Luís Alves. "Increasing the Penetration of Renewable Energy Resources in S. Vicente, Cape Verde." *Applied Energy* 88.2 (2011): 466-72.
- Shannon, R.e. "Introduction to the Art and Science of Simulation." 1998 Winter Simulation Conference. Proceedings (Cat. No.98CH36274)(1998): n. pag. Web.
- Sterman, John. *Business Dynamics: Systems Thinking and Modelling for a Complex World*. Boston: Irwin/McGraw-Hill, 2000
- Strachan, Neil, and Alexander Farrell. "Emissions from Distributed vs. Centralized Generation: The Importance of System Performance." *Energy Policy* 34.17 (2006): 2677-689.
- Supply side analysis, 2012 – The mid-, and long term supply side capacity development of the Hungarian electrical system, Original work: "A Magyar Villamosenergia-rendszer Közép- és Hosszú Távú Forrásoldali Kapacitásfejlesztése 2013 Magyar Villamosenergia-ipari Átviteli Rendszerirányító ZRt., 02 Jan. 2014. http://www.mavir.hu/documents/10258/15461/Forr%C3%A1selemz%C3%A9s_2012.pdf/afac965c-b567-4738-af14-847a94013532 [accessed: 2014.01.11.]
- Supply side analysis, 2013 – The mid-, and long term supply side capacity development of the Hungarian electrical system, Original work: "A Magyar Villamosenergia-rendszer Közép- és Hosszú Távú Forrásoldali Kapacitásfejlesztése 2013 Magyar Villamosenergia-ipari Átviteli Rendszerirányító ZRt., 05 Jan. 2014. http://www.mavir.hu/documents/10258/15461/Forr%C3%A1selemz%C3%A9s_2013.pdf/0a51f06c-73e7-4607-b582-00d3b1434837 [accessed: 2014.01.11.]
- Tehrani, S. Saeed Mostafavi, Majid Saffar-Avval, Sahand Behboodi Kalhori, Zohreh Mansoori, and Mehdi Sharif. "Hourly Energy Analysis and Feasibility Study of Employing a Thermocline TES System for an Integrated CHP and DH Network." *Energy Conversion and Management* 68 (2013): 281-92.
- Weis, Timothy M., and Adrian Ilinca. "The Utility of Energy Storage to Improve the Economics of Wind–diesel Power Plants in Canada." *Renewable Energy* 33.7 (2008): 1544-557.

Woess-Gallasch, Susanne, Neil Bird, Peter Enzinger, Gerfried Jungmeier, Reinhard Padinger, Naomi Pena, and Giuliana Zanchi. "Greenhouse Gas Benefits of a Biogas Plant in Austria." *JOANNEUM RESEARCH Forschungsgesellschaft MbH. RESOURCES - Institute of Water, Energy and Sustainability* (2011): n. pag. *IEA Bioenergy Task 38 Case Study Report*

Wu, B. *Manufacturing Systems Design and Analysis*. London: Chapman & Hall, 1992. Print.

