



INTEGRATION OF THE PASSIVE AIR CONDUCTION SYSTEMS' AERODYNAMIC DESIGN INTO INDUSTRIAL BUILDINGS

Thesis Book

by

Ádám László KATONA

to

Breuer Marcel Doctoral School of Architecture,

The University of Pécs, Faculty of Engineering and Information Technology

for the degree of

Doctor of Philosophy in the subject of

Architecture engineering

Pécs, Hungary

2022

1. Introduction and Literature review

New studies and reports are published on a daily basis about the dangers of climate change and its main reason, humanity's constantly growing population, built floor space and resource consumption. The built environment is responsible for approx. 40% of the total energy consumption, and a huge portion of energy demand in buildings comes from heating, ventilation, and air conditioning (HVAC). Low-carbon technologies become more popular in recent years, mainly because of the aim to reduce the greenhouse effect and to save energy and natural resources.

The main benefits of Natural Ventilation (NV) are the lower operation energy cost in contrast to mechanical ventilation (MV) and the improved air quality (IAQ) in the indoor environment [1]. Many parameters should be analyzed carefully to achieve these advantages and the main design of NV is being approved in the design phase. Unfortunately, NV is still not recognized in the regulations, therefore it cannot be calculated in a standardized way. In addition, NV requires an appropriate understanding of building pressurization, façade design [2], wind patterns, and local climate conditions, which only can be achieved by a specific design method, instead of Net Zero Energy Building (NZEB) standard or any other legislations and codes. Currently, the most developed regulations are created by the American Society of Heating, Refrigerating, and Air-Conditioning Engineers (ASHRAE). The ASHRAE 62.1 and 62.2 [3] considers the topic of MV & NV and their IAQ. It provides appropriate sizing values for the design of MV systems as well as simple NV systems (e.g., one- or two-sided window ventilation, etc.). However, there exists no calculation or modelling guidance for unconventional or complex systems. Only simplified, approximated equations, rule of thumb table-data, as well as general calculation and simulation descriptions are provided.

It can be observed from the tendencies, that solely the political alignments and the legal regulations are not sufficient to achieve a sustainable future; therefore, it is needed to pursue and to introduce groundbreaking new technologies, which could even deliver better results than the minimum requirements of current environmental legislations.

Passive ventilation is an increasingly popular method to reduce building energy use by drawing in fresh air without the aid of mechanical equipment. In buoyancy-driven natural ventilation systems, appropriate air inlets in the building envelope and vertical connection between each floor must be provided directly connected to an exhaust opening, typically located in or on the roof structure. These design elements and structures need to be defined in the early design stage.

In most cases, wind flow influences even stronger the building ventilation performance, infiltration rates, and the associated heat losses or gains [4]. Therefore, the building envelope bears great importance in buildings' energy behavior: the façade and roof performance, i.e., form (geometry), structure and openings should be improved according to indoor requirements and the surrounding outdoor environment conditions and neighboring structures, since they modify the local microclimatic flow characteristic and may cause unexpected effects. Appropriate aerodynamic building design, in turn, enables to benefit from given circumstances, creating air pattern responsive solutions.

The focus of my studies are the so called wind towers. The reason behind this decision is complex, but the main governing factor is the industrial halls' large floor area ratio to their heights. The roof integrated openings are usually based on a direction of the building; they are more rigid as ventilation solution compared to the local wind climate or the neighbor buildings. If we use vertex based outlets (i.e. towers, skylights etc.) the system can be designed more flexible to the directions, functions, requirements etc.

Since Bahadori's [5] first publication about the vernacular wind catchers in Iran, the vertical wind driven building structures came to the spotlight in the field of natural ventilation. These so-called "baud-geers" caught the wind on their top openings and drove the air currents down to the interior, thus ensuring fresh air supply and cooling of the overheated internal spaces. The available studies about vernacular and modern implementation of wind catchers proved that this solution was not only sufficient in the ancient era, but is able to satisfy higher needs. However, the use of wind catchers is only an option of a passive air conduction systems (PACS). The determination of the right geometry based on the local functions, building shape, structure and dimensions, urban texture and meteorological data is essential for further performance improvement and savings in financial-, energy-, environment and time resource. More than one method exists to achieve NV with towers, e.g. wind towers with up-ward air movement (updraft ventilation), combined wind towers with solar chimneys, multiple towers with differentiated purpose, evaporative cooling effects, etc. The difference between these options is often blurred, and for scientific purpose, there are no strict definitions for the different operational methods or geometries to be found. From aerodynamic approach the lack of boundaries is not problematic, because the architectural difference between a skylight and a tower can be negligible from the airflow's point of view. On the other hand, from scientific approach it is very difficult to find general answers or optimal solutions in the literature if the boundaries are set by architects, or not defined at all.

The literature review outlines well the need for spreading NV in industrial buildings. A good founding is provided by vernacular tower structures, but in the last decades, the investigations were more focused on the justification of the PACS against MV systems. Currently, their relevance is meanwhile proven, and their application is inevitable because of the global warming and its negative effects. My research became necessary because during a design phase of new buildings, it is impossible to collect suitable information from the literature to properly create not just a working, but also a specified and precisely scaled NV system in given boundary conditions. It became clear that there is a deficiency in studies concentrating on comparison of different PACS, which could be helpful for architects and engineers to choose the appropriate PACS with optimal parameters for a given building application.

The complexity of the aforementioned aspects is the reason why building designers often do not consider NV. The lack of knowledge in this field and the missing expertise for evaluation and implementation may result in poorly designed, constructed and operated naturally ventilated buildings. Therefore, scientific need emerges for building a wide and thorough knowledge about wind catcher topology, which functions as guideline in such design and sizing situations. The purpose of this dissertation is to expand this field with new methods, geometries, identify important parameters, to create a basic practical insight for general design of a new PACS in industrial buildings.

2. Methodology

Multiple methods could be used to predict ventilation in theoretical research studies [6]. Among them, computational fluid dynamics (CFD) has been the most advanced method for predicting NV performance [7,8] and among the numerous simulation tools available, CFD models have become one of the most popular in the literature, accounting for 70% of publications on simulating building ventilation reviewed by Chen [9]. The current research is therefore based on CFD to assist architects in the development and optimization of NV behavior in buildings.

CFD simulations need highly educated human resource and special software, hardware, therefore, only few NV concepts can reach the executing stage with such design method. This

The comparison of CFD simulation showed that experimental measurements (Fig. 1.) revealed almost identical local air temperatures and wind velocities, while flow rates closed up the measured values with acceptable error rates. (Fig. 2.)

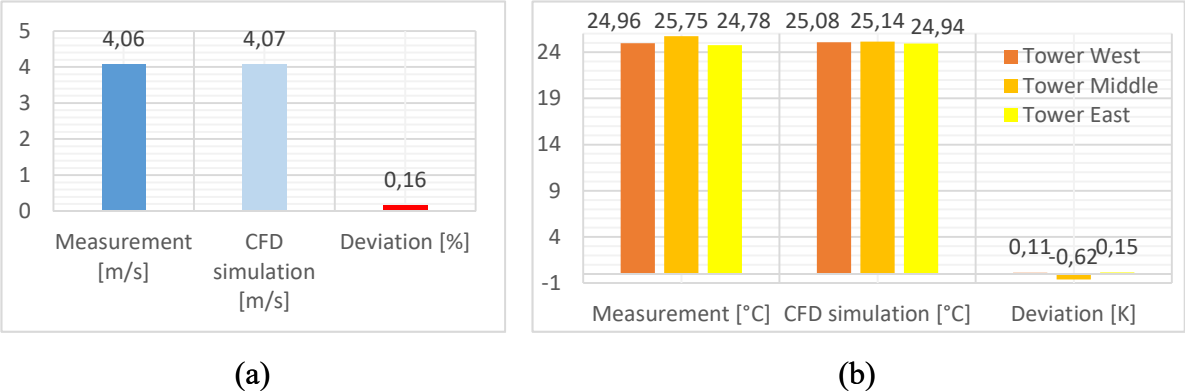

Figure 2. Measured and simulated wind velocity (a) and air temperature (b) comparison in the three ventilation towers.

In the future this validated CFD model became suitable to investigate the influencing factors of major geometry changes, arrangement variations and different types of PACS’s operation principles. Therefore, valuable results could be exploited about the geometry settings of the towers. These results have shown that the buildings PACS, which was designed by the ED method, were not fully optimal, because the achieved ventilation rates (8.72 h^{-1}) suggested that only two towers would have been sufficient to create acceptable IAQ in the production hall. With this modification the construction would have been faster and cheaper, extra interior space would have been freed, and a clearer and optimized PACS would have been applied to the building. The results are not devaluing the ED method significance, but shows the importance of high resolution CFD simulations even in the design phase for cost and energy efficiency. There is possibility in my opinion, that not only the numbers of towers are too much, but maybe even smaller cross sections could be efficient for one tower each. In Figure 3. It can be seen, that the airflow inside the shafts are not goingt straight outdoor, but they have huge vortices, where they can lose kinetic energy.

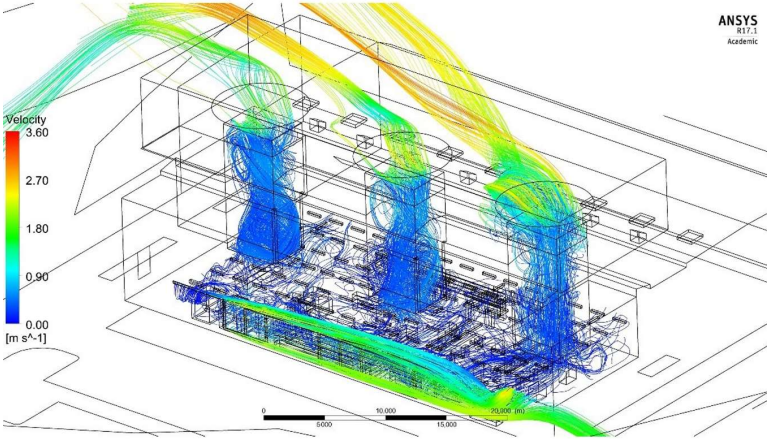

Figure 3. Pathlines drawn by the velocity inside the towers and the production hall of the prototype building. The airflow is not straight, but containing vortices, therefore it loses kinetic energy

Finding 1.

The ENERGIA DESIGN® planning method was proposed by Kistelegdi in 2013. The proposed method was used during the design process of the RATI Ltd.'s new industrial complex. The building contains a complex Passive Air Conduction System with three wind towers. A high-resolution Computational Fluid Dynamic model was developed for investigating the building ventilation performance and compare it with in situ measurements. The validated model showed that instead of three wind towers only two could have been sufficient to maintain acceptable comfort level in an approximately 600 m² industrial hall with 4.5 m height and light industrial occupancy. These results highlight the importance of detailed complex aero dynamical simulations in the design phase, therefore, it can save significant amount of energy and money.

The thesis approves the novelty and pioneer ways of the Energy Design® method, however the possible improvements were clarified by the newly obtained results.

Related publication: [10]

3.2. Macro scaled PACS optimization – Definition of the wind direction independency of updraft and down draught ventilations systems.

The design of a new winery was started in 2017 in Villány, Hungary. The industry section of the boutique hotel and winery was represented by a traditional cellar and a modern production hall in the building – both sub terrain spaces. The ventilation in these two rooms should have been solved by PACS. Two different solutions were considered to exploit the wind as resource: a Down Draught (DD) and an Up Draft (UD) PACS. In both cases, an UD directed wind tower provided exhaustion of stale air, under a pyramid roof, which helps to transfer the horizontal winds over the peak of the roof at the tower opening. The fundamental difference between the two systems is the driving force for the air movement in the interior. In case of the UD PACS, the tower is equipped with a ‘Venturi-plate’ and the formulated depression zone under it is the main wind driven operator. The fresh air is originated from two underground industrial gates on the opposite side of the building (Figure 3a). The updraft tower structure can be found in the DD PACS version also, but the fresh air is delivered by a separated modern wind catcher (Figure 3b). On top of the DD wind catcher a special chimney crown is designed, which operates similar to the traditional ‘baud-geers’. The over pressured zone on the opening of the tower is introducing and forcing down the fresh air to the interior.

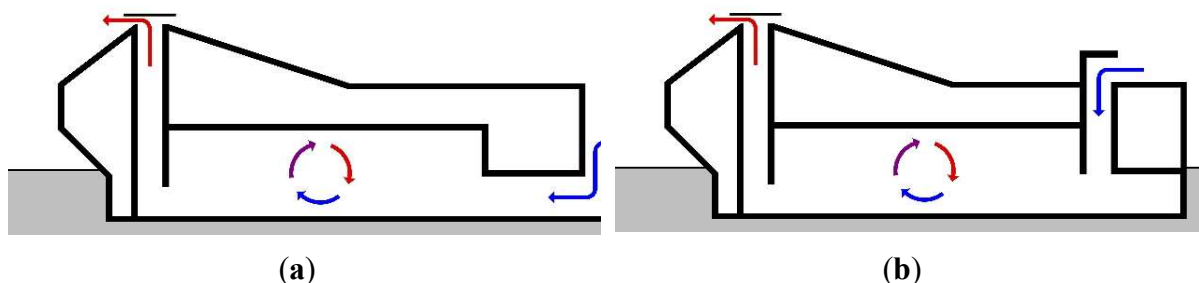

Figure 3. The two investigated PACS method: (a) updraft (UD) and (b) down draught (DD).

I organized and operated a series of CFD simulations where 8 wind incident angles were considered, therefore, a general experience could have obtained. Based on the results I could successfully evaluate the current situation of the new winery building. In Figure 4. it is visible,

that both rooms were sensitive when the UD tower was applied to the orthogonal directions to the main axis of the building. However, the two parallel directions created outstanding performance values. The DD solutions were more evenly distributed by the wind directions, and less amplitudes were resulted, but every direction achieved acceptable level of comfortable air change rate. From these results a very characteristic property of the two different PACSs were identified.

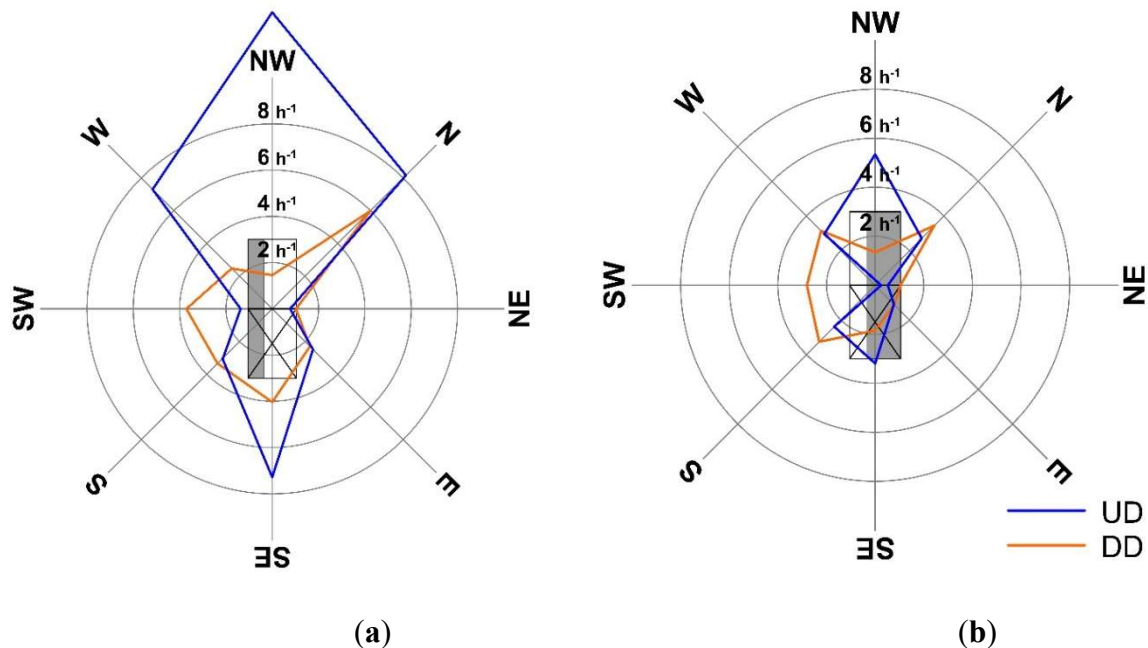

Figure 4. Results of air change per hour (ACH) [h^{-1}] (a) in the cellar and (b) in the production hall where grey shows the mentioned area in the sematic figure of the building

Finding 2.1.

An up draft passive air conduction system’s ventilation performance has huge amplitudes when the wind direction is aligned with the system’s main axis (in case of linear flow between outlet and inlet openings), but the other directions has poor capacity. Therefore, the up draft system can be identified as a bidirectional Passive Air Conduction System.

Related publication: [11]

Finding 2.2

On the other hand, a down draught system has no extreme high ventilation potential in one particular wind direction, but in the same situation, every direction can achieve sufficient performance, therefore the down draught system can be identified as an omnidirectional Passive Air Conduction System.

Related publication: [11]

3.3. Development of a coaxial PACS in large scaled industrial buildings

According to my previous plan, the validated CFD model can serve as a foundation for next generation PACS model's CFD simulation, I started to develop a basic prototype that serves as a modular unit for spacious, multi-functional public building functions like event-space, commercial use, convention, conferences, exhibitions, offices, education, industry halls, etc. with greater net floor space. After development of a well-working basic unit module, it should be arranged side by side to create an assembled, large-sized multiple-unit building. The first desired universal building prototype should comprise approx. 6 000 m² net floor space with a passive, wind direction independent ventilation system.

Corresponding to the basic unit concept, the validated, up draught ventilated reference building CFD model geometry was reconstructed. The layout of the module consists of two pieces of 27.5 x 27.5 m square areas with a height of 5.5 m. In the empty geometry, I have also included heat-generating units (people, electrical equipment, machinery, artificial lighting) to obtain more realistic values, where the values and occupancy behavior were gained from the base model too. The resulting floor area (765.25 m²) is almost identical to the production hall (610 m²) of the reference model studied above, and therefore the proportional data for users, artificial lighting and hall equipment were used as a sample. This allowed us to simulate the heat production of a real production situation.

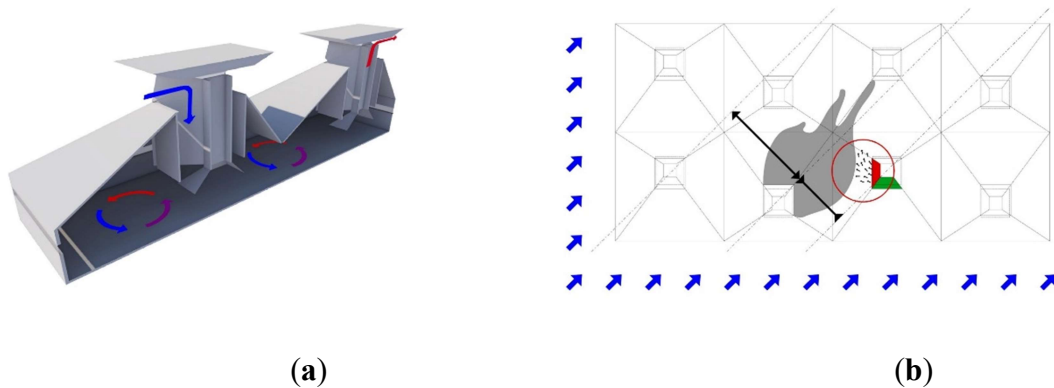

Figure 5. 3D model of the proposed industrial PACS module and its ventilation conception (a) combined module system's problem identification step (b)

The tower system was generated as a combination of the DD and the UD PACS towers. A coaxial version was designed, where the center shaft can work as an UD system with a 'Venturi' baffle on top, and the surrounding outer shafts are saving as a DD, with variable opening combinations, to direct it to the actual slope wind incident angle (Figure 5.a). The towers received a pyramid roof structure with 45° slope angle, so there was no vertical wall to reduce the incoming wind ventilation potential. The pyramids peak point was the coaxial tower's top, so it has lead the wind with swift transition over the tower openings. This change came from the mentioned investigated and validated CFD model of Section 3.1.

The simulations were obtained first in a simple two units version (with one inlet and one outlet. And after the first promising results a combined eight units version was tested also from different directions. The performance of the tower was sufficient, because from different directions the ACH occurred between 2.37 and 5.63 h⁻¹ in the different cases. It would be too complex to describe the details here, but one phenomenon is worth to introduce. In certain wind directions, a typical phenomenon occurred: some tower openings were not operated as designed originally (input – output functions mixed). Figure 5b shows the method, how the tower's unwanted operation was identified and explained. In this situation the red zone should have worked as an inlet, however the grey backflow zone changed the pressure circumstances

fundamentally, therefore it switched the original inflow direction. The results were promising, and I would describe the system as a reliable solution for large industrial facilities. However, further analysis is required to exclude and regulate the mentioned unwanted behavior around the towers in the combined version. In this Ph.D.'s timeframe it was not possible to conduct these required simulations.

The complete prototype wind-induced ventilation characteristic of the four basic units is a high performance passive system that is basically wind-independent. It can be stated that the basic operating mechanism of the system is reliable.

Finding 3.

If the intended ventilated area has huge distances from the façade openings, the most cost and performance efficient Passive Air Conduction System solutions are roof structure integrated vertical down draught and up draft elements.

A new coaxial chimney structure was developed, whereas the down draught principle ensures the fresh air inlet, and the up draft system conducts the stale exhaust air from the interior to the outdoors. The temporary function of a chimney system depends on the actual wind incident angle, which can be modified by a building management system. The developed Passive Air Conduction System unit can maintain acceptable air change rate (5.63 h^{-1}) in a 765 m^2 industrial hall and even works efficiently (5.16 h^{-1}) in a multiplied version (8 pieces of arranged basic units) where the area increased to $6,000 \text{ m}^2$.

However, in the large version there can be complications with the suitable opening management, due to unintended airflow directions occurred in the chimneys, due to the flow distribution between and around the towers.

Related publication: [12]

3.4. Micro scaled optimization of a down draught PACS chimney crown structure

The sufficient information about the NV structures' precise sizing, scaling and geometrical parameters, in particular given boundaries are usually not available. According to the quality and quantity of the gained results from literature, the outlining knowledge about the shape design of ventilation structures is apparently incomplete. Such questions remained open: Which detailed geometry versions offer a better solution for the chosen PACS? How and what kind of topology of natural ventilating structures should be chosen for a PACS in an industrial building to achieve the highest possible ACH? It was my aim to reply these questions, at the same time, reasonable structural and architectural design aspects are need to be considered during my shaping and optimization process. The purpose of this phase is to expand this field with new versions and results along the reviewed authors.

My research continued the optimization process with the already developed DD PACS, mentioned in section 3.2. The PACS's inlet structure was chosen for geometry investigation. For optimal air inlet design, the transition of the entering air movement is crucial, i.e., as little as possible turbulence and vortices are desired, to avoid unwanted contra-productive currents against the air supply's direction. Four different geometries were selected, based on the work of Ford et al. [13], which should operate sufficiently. The geometry variations are presented on Figure 5. The first case is the 'empty' wind catcher – base case (Figure 5a). The second is the 'circle' (Figure 5b), where the radius of the curved inwards and downwards deflecting surface is the height of the inlet openings (the right side of the figures). The third one has a 'parabolic' curve (Figure 5c), while the fourth version was equipped with the same wind catcher topology as the third, but the tower's cross section was modified as a hyperbolic bell (Figure 5d).

Figure 5. Conception of the wind catcher inlet structure shape; empty' geometry (a); 'circle' (b); 'parabola'(c) and parabola with 'hyperbola' bell in the tower (d).

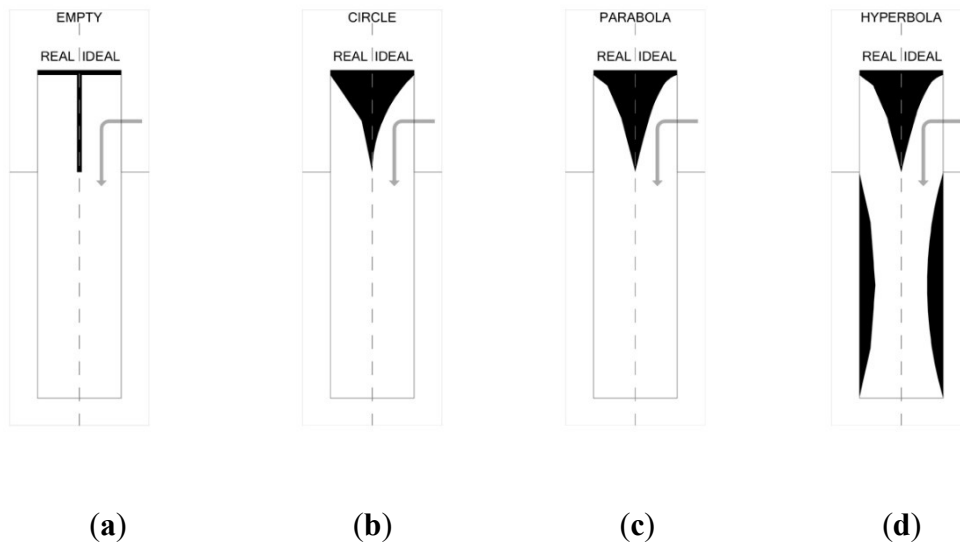

A wind direction independent, roof-integrated inlet structure was developed. The results are shown on Figure 6. described by three different wind incident angles (cross is orthogonal to the inlet outlet axis; longitudinal is parallel; and diagonal is in 45°angle with it) and an average performance. (determined by the air change rate) Through the study based on the first results multiple modification were applied to the diagonal deflectors to optimize the capacity of the geometry. In first step a significant upsizing of the wind catchers' deflector walls (by 211%) by simultaneously keeping the same inlet opening dimensions. With the changes the tower had bigger surface for wind collection, but at the same time some contra productive counter currents occurred close to the roof. The reason behind this was that the enhanced inlet surface tried to force down more air into the shaft than its capacity by the cross section's area. So in the second step – in order to gain improvements in all directions, and lose the vortices in front of the inlet – the enlarged deflectors' lower part should be trimmed back to the initial inlet opening edge. In this way, significant improvement could be achieved in all wind directions.

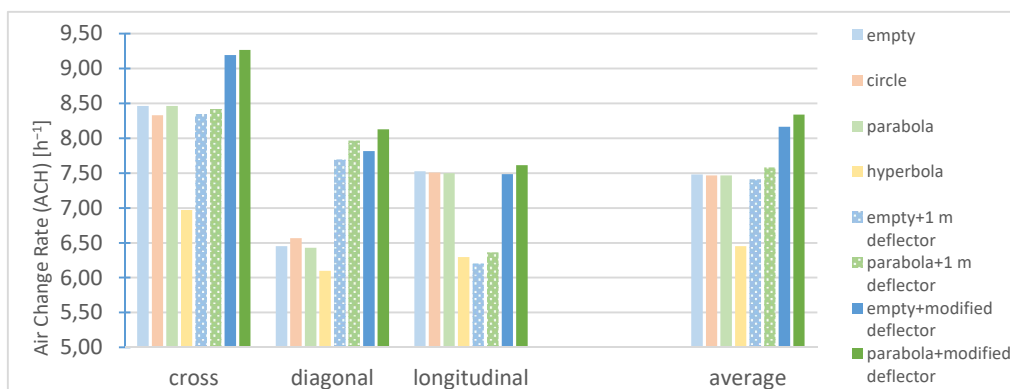

Figure 6. Comparison of geometry variations' performance in ACH [h^{-1}] with the modified deflectors of the 'empty' and 'parabola' versions.

Finding 4.1

The micro scaled optimization of a Passive Air Conduction System's component, delivers as significant improvements for the ventilation performance, as the macro scaled systematic design of a complete PACS sizing procedure. Based on the obtained results of a complex geometry improvement process, the ventilation rate can be even increased by 25%. Therefore, the micro-optimization is suitable not just newly designed buildings, but it creates a high impact solution for existing buildings' Passive Air Conduction System's refurbishment or equipment as well.

Related publication: [14]

However, the original work of Ford et al. [13] work was done in a tower with a 3.75 m diameter. This means that the cross section's area was approximately 3.5 times larger than in my studies, so for more universal insights, the possible generalization of the results can be advantageous. Here less significant differences were achieved between the different variations, compared to Ford et al.'s work, therefore, the following statement can be made.

Finding 4.2.

The wind catcher's geometry variations' results in air change rate converge with the downsizing of the ventilating tunnel's cross section area. Therefore, there is a minimum limit for micro scaled optimization of PACS components, where the extra cost in design, money and construction is overstepping the gains of the optimized geometry.

Related publication: [14]

3.5. Parametric optimization of a PACS Venturi roof outlet structure

The main objective of this step was to investigate the parametric sensitivity of the geometric dimensions of a PACS structure for passive ventilation. The selected situation was the exhaust vents of tower-like structures built on top of industrial halls. So-called 'Venturi' baffles are placed above the tower structures (Figure 7), under which the pressure of the accelerating air mass in the constricted flow cross-section is reduced, creating a depression zone, during which, by opening the exhaust towers, the extraction of the stale air inside can be increased, and this is a completely natural way by means of wind.

In this research, I have taken, as a basis, a typical industrial hall structure, where a large internal air volume is developed in the cross-section and this typical cross-section does not change significantly in the longitudinal direction. This characteristic of the hall allowed me to perform the CFD simulations of the airflow characteristics in two dimension, which can be used to optimally calculate the properties of a ventilation system without the aid of physical models (which are cost and time consuming). This solution saved a lot of computational capacity, which I could use in this case to not only consider two variants in my research, but to evaluate all combinations of certain parameters and their combined effect on the whole system. In this case, I chose three main parameters with three variable, so that their combinations represented $3 \times 3 \times 3 = 27$ case. The three main parameters were the height (h), the width (d) and the angle (a) of the compression zone (Figure 7). The main significance of the research is that the combination options outlined above show very little variation in terms of structural design, so they do not change the budget significantly. Thus, with design effort alone, I hypothesized that a significant performance improvement could be achieved, thus increasing the efficiency of

natural ventilation and thus reducing the energy consumption of the building - leading to both financial and environmental savings.

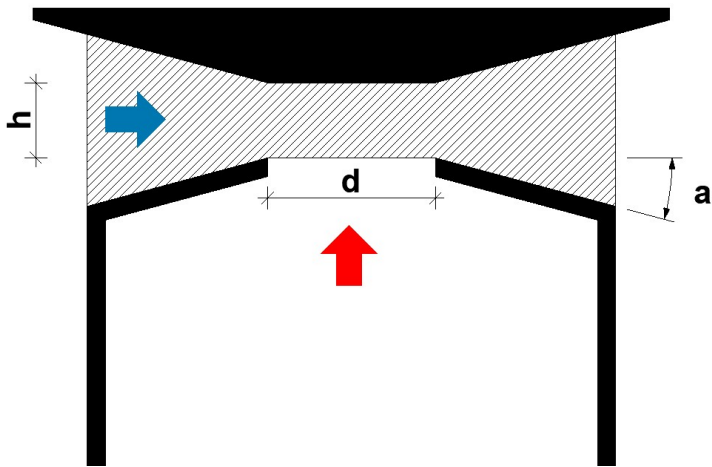

Figure 7 - Visual representation of the decompression zone, where h = the height of the zone, d = the width, a = the angle of contraction. The blue arrow indicates the wind direction, while the red arrow indicates the internal stale air.

The results of the research are scientifically valuable for two reasons. The first reason is that a clearly optimal solution has been found within the boundary conditions of the given parameters, making the method presented here suitable for industrial use (Figure 8). It can be easily adapted to the optimization of structures under the conditions that arise in a given design task and, by analogy, under the conditions defined by other design criteria.

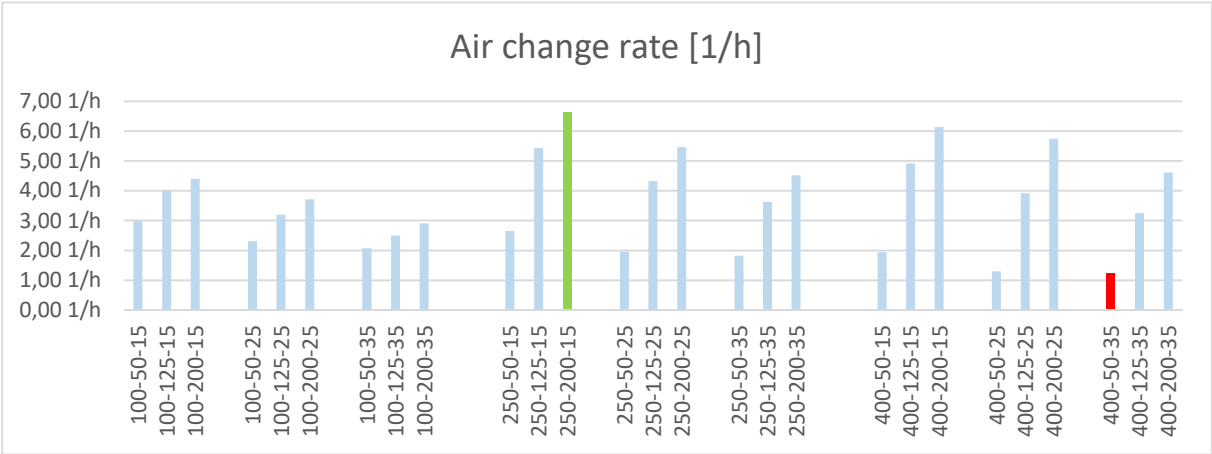

Figure 8 - Comparison of the ventilation capacities of the 27 cases studied using the air exchange rates obtained [h⁻¹]

The second main result of the research is that conclusions can be drawn about the impact of all three parameters on ventilation:

- the width of the zone ($d=100; 250; 400$ cm) - where the comparison shows an ideal result of the medium width, as both extremes performed worse than the mean.

- zone height ($h=50; 125; 200$ cm) - where the clear trend is that the higher the compression zone, the more effective the ventilation. However, the present results require that further values are added to the parameter scale to show how long this increase lasts and what optimum can still be achieved.
- the angle of compression of the zone ($\alpha=15^\circ; 25^\circ; 35^\circ$) - where the tendency is also clear, namely that performance decreases as the angle increases. It would be equally worthwhile to further extend the range of parameters to determine the optimum.

The above cases therefore do not yet provide generalizable optimal operating principles, but they do present a generalizable optimization process for specific design cases. Furthermore, clear trends can be identified on the influence of different parameters on the efficiency of the overall structure. This will facilitate the definition of trajectories for similar research in the future. However, the first impressions of this parametric method can support the following statement.

Finding 5.

The parametric approach of Passive Air Conduction System optimization has great potential in the field of industrial buildings' passive ventilation. Compared to a conventional planning solution, with the generated 3x3x3 parametric matrix the ventilation performance of the determined 'Venturi' structure's compression zone increased up to 544%. A scientifically thorough generated parametric matrix can point out the most effective version of a Parametric Air Conduction System's geometry in any given boundaries.

The simulations were run in 2D, because even with simple parameters the evaluation process is largely time consuming, and the building characteristics made this 2D approach possible. Future studies need to develop a method to solve the time factor for more complex situations.

Related publication: [15]

4. Outlook

Due to the lack of PACS variation assessments in literature, it can be stated that not only the different NV systems need more evaluation, but also the optimization of a chosen method is also difficult, because of the lack of appropriate quantity and quality of results. Therefore, in future studies it would be rewarding to investigate different aspects of individual PACS with a parametric method to obtain the optimum version(s) of all feasible designs. Possible parameters are, for instance, geometrical variations of the inlets and outlets, the 'Venturi'-objects or the inlet chimney crowns—e.g., height, cross-section, shape, number, arrangement, and the relative positions to each other, etc. Since a PACS should not only produce as much fresh air as possible but needs to ensure other comfort aspects also, further factors such as humidity and temperature should be considered in future studies as well. By substantiating the obtained and concluded knowledge, a new guideline should be written from the experiences for architects and NV designers in the future.

For future research, a challenge will be the complex investigation of geometry parameters, where the dimensions are not separately tested, but their permutations as well. The difficulties come from the numerous generated variations. If only a simple wind catcher is taken for examination, at least four basic parameters are required to calculate (e.g. height, width, tower section separation by deflectors, geometrical shape of the inlet surface, etc.), and for the acceptable fine trends additional three to four variations of each parameter should be calculated.

It means that a simple series of CFD simulations start with a minimum of $4^4 = 256$ cases, consuming a huge amount of calculation time. Despite of the number of permutations, to find the cost and energy efficient wind catcher version for a large variety of situations, the mapping of the aerodynamic optimum is indispensable in the future.

The above-mentioned geometry optimizing future research tasks should generate a generic dataset system of shape dimension parameters for engineers to enable efficient ventilation design.

The following text is written by Horváth [16] in his Ph.D. dissertation.

“[...] Today's traditional building design method is not sufficiently focused on energy-optimal performance due to a heuristic experience-based process. The general mindset in conventional building design ignores building geometry as one of the most integrated energy efficiency related variables in the design phase, further, usually only a few number of scenarios are considered, and therefore planning decisions are based on experience. The Energy Design (ED) method is more systematic/regulated and has created a framework for the design process, using more concepts of energy performance, as well as simplified calculations and simulation-based decision making. A new methodology was needed because the standards are not comprehensive and are not sufficient to create comfortable, energy efficient buildings and thus an environmentally conscious and sustainable future. The Energy Design Synthesis (EDS) method is an enhanced version of ED, which aims to provide a comprehensive solution and a guaranteed optimal building development. EDS involves the creation of efficient rules for detecting feasible and possible cases of an objective function by minimizing the amount of sampling and thus minimizing the computational time cost. It identifies the optimal solution(s) according to a predefined set of user preferences for energy and comfort performance. It follows that the Energy Design Synthesis Method will be able to deliver better results than the Energy Design Method, taking into account the above-mentioned aspects. [...]”

The presented EDS is the upgraded version of the ED method, where – as it is shown in section 3.1 – non optimal but reliable solutions are designed, but not optimized. The new EDS offers a huge opportunity for preprocessing in the PACS designing method, because of the huge computational requirements every bit of time and energy saving scan improve the optimization process. The EDS method's key element is the development of a regressive solution finder model, where all mathematical option is taken into account, and not just the ‘thumb rule’ solutions are chosen by the designer, where the engineer's scientific competency is defining the success. This kind of general thinking without any prejudice can be really useful for complex aerodynamic systems' evaluation. However, the hugest impact of the regressive model is the time saving, because it can calculate all the versions potential with only a few input scenarios dataset, therefore the mentioned $4^4=256$ cases do not need to be simulated manually one by one. This time efficiency is barrier for current simulations.

5. Publications connected to the results

- [10] Á.L. Katona, H. Xuan, S. Elhadad, I. Kistelegdi, I.E. Háber, High-Resolution CFD and In-Situ Monitoring Based Validation of an Industrial Passive Air Conduction System (PACS), *Energies*. 13 (2020) 1–23. <https://doi.org/doi:10.3390/en13123157>.
- [11] Á.L. Katona, I.E. Háber, I. Kistelegdi, Comparison of downdraught and up draft passive air conduction systems (PACS) in awinery building, *Buildings*. 11 (2021). <https://doi.org/10.3390/buildings11060259>.
- [12] Á.L. Katona, I. Kistelegdi, Energy saving passive ventilation and cooling provided by building structures, in: I. Péter, F. Attila (Eds.), *Abstr. 14th Miklós Iványi Int. PHD&DLA Symp.*, Pollack Press, Pécs, 2018: pp. 95–96.

https://issuu.com/pivanyi/docs/abstract_book_2018?utm_medium=referral&utm_source=phdsymp.mik.pte.hu.

- [14] Á.L. Katona, I.E. Háber, I. Kistelegdi, CFD Simulation Supported Development of Wind Catcher Shape Topology in a Passive Air Conduction System (PACS), *Buildings*. 12 (2022). <https://doi.org/10.3390/buildings12101583>.
- [15] Á.L. Katona, I. Kistelegdi, Parametric sensitivity analysis of Venturi roofs' ventilation performance with 2D CFD simulations, in: L.F. Kajos, C. Bali, Z. Dr. Preisz, P. Polgár, A. Glázer-Kniesz, Á. Tislér, R. Szabó (Eds.), *Interdiscip. Dr. Conf. - B. Abstr.*, Pécsi Tudományegyetem Doktorandusz Önkormányzat Doctoral Student Association of the University of Pécs, Pécs, 2021: p. 74. https://dok.pte.hu/sites/dok.pte.hu/files/files/Kiadvanyok/IDK2021_Book_of_Abstracts.pdf.

6. Bibliography

- [1] Z. Tong, Y. Chen, A. Malkawi, Z. Liu, R.B. Freeman, Energy saving potential of natural ventilation in China: The impact of ambient air pollution, *Appl. Energy*. 179 (2016) 660–668. <https://doi.org/10.1016/j.apenergy.2016.07.019>.
- [2] G. Chiesa, M. Grosso, D. Pearlmutter, S. Ray, Advances in adaptive comfort modelling and passive/hybrid cooling of buildings, *Energy Build.* 148 (2017) 211–217. <https://doi.org/10.1016/j.enbuild.2017.05.012>.
- [3] K.L. Peterman, M. Weber, eds., *ASHRAE Standard 62.1-2019 - Ventilation for acceptable indoor air quality*, American Society of Heating, Refrigerating and Air-Conditioning Engineers Bookstore, Atlanta, GA, 2019. <https://www.ashrae.org/technical-resources/bookstore/standards-62-1-62-2>.
- [4] B.R. Hughes, C.M. Mak, A study of wind and buoyancy driven flows through commercial wind towers, *Energy Build.* 43 (2011) 1784–1791. <https://doi.org/10.1016/j.enbuild.2011.03.022>.
- [5] M.N. Bahadori, Passive Cooling Systems in Iranian Architecture, *Sci. Am.* 238 (1978) 144–154. <https://doi.org/10.1038/scientificamerican0278-144>.
- [6] Y. Li, P. Heiselberg, Analysis Methods for Natural and Hybrid Ventilation - a Critical Literature Review and Recent Developments, *Int. J. Vent.* 1 (2003) 3–20. <https://doi.org/10.1080/14733315.2003.11683640>.
- [7] S.D. Ray, N.W. Gong, L.R. Glicksman, J.A. Paradiso, Experimental characterization of full-scale naturally ventilated atrium and validation of CFD simulations, *Energy Build.* 69 (2014) 285–291. <https://doi.org/10.1016/j.enbuild.2013.11.018>.
- [8] N. Khan, Y. Su, S.B. Riffat, A review on wind driven ventilation techniques, *Energy Build.* 40 (2008) 1586–1604. <https://doi.org/10.1016/j.enbuild.2008.02.015>.
- [9] Q. Chen, Ventilation performance prediction for buildings: A method overview and recent applications, *Build. Environ.* 44 (2009) 848–858. <https://doi.org/10.1016/j.buildenv.2008.05.025>.
- [10] Á.L. Katona, H. Xuan, S. Elhadad, I. Kistelegdi, I.E. Háber, High-Resolution CFD and In-Situ Monitoring Based Validation of an Industrial Passive Air Conduction System (PACS), *Energies*. 13 (2020) 1–23. <https://doi.org/doi:10.3390/en13123157>.
- [11] Á.L. Katona, I.E. Háber, I. Kistelegdi, Comparison of downdraught and up draft passive air conduction systems (PACS) in awinery building, *Buildings*. 11 (2021). <https://doi.org/10.3390/buildings11060259>.
- [12] Á.L. Katona, I. Kistelegdi, Energy saving passive ventilation and cooling provided by building

- structures, in: I. Péter, F. Attila (Eds.), *Abstr. 14th Miklós Iványi Int. PHD&DLA Symp.*, Pollack Press, Pécs, 2018: pp. 95–96.
https://issuu.com/pivanyi/docs/abstract_book_2018?utm_medium=referral&utm_source=phdsymp.mik.pte.hu.
- [13] B. Ford, B. Ford, M. Street, L.E.I. Uk, Cooling without air conditioning, *Renew. Energy*. 15 (1998) 177–182.
- [14] Á.L. Katona, I.E. Háber, I. Kistelegdi, CFD Simulation Supported Development of Wind Catcher Shape Topology in a Passive Air Conduction System (PACS), *Buildings*. 12 (2022).
<https://doi.org/10.3390/buildings12101583>.
- [15] Á.L. Katona, I. Kistelegdi, Parametric sensitivity analysis of Venturi roofs' ventilation performance with 2D CFD simulations, in: L.F. Kajos, C. Bali, Z. Dr. Preisz, P. Polgár, A. Glázer-Kniesz, Á. Tislér, R. Szabó (Eds.), *Interdiscip. Dr. Conf. - B. Abstr.*, Pécsi Tudományegyetem Doktorandusz Önkormányzat Doctoral Student Association of the University of Pécs, Pécs, 2021: p. 74.
https://dok.pte.hu/sites/dok.pte.hu/files/files/Kiadvanyok/IDK2021_Book_of_Abstracts.pdf.
- [16] K.R. Horváth, I. Kistelegdi, Award winning first Hungarian active house refurbishment, *Pollack Period.* 15 (2020) 233–244. <https://doi.org/10.1556/606.2020.15.2.21>.